



**SG-2000
1.6-30 MHz
150 Watt Output
Multi-Mission
HF SSB
Transceiver**

Operations and Programming Manual

Revised: Oct, 1995

CAUTION: Carefully read the "Quick Start" (yellow card packed with your radio) and the "Operating the SG-2000" section of this manual beginning on Page 41. The SG-2000 is a high precision electronic device. Taking the time to learn all of its capabilities will insure maximum performance, reliability and enjoyment of the unit.



TABLE OF CONTENTS

1.0	General Description and Specifications	1
1.1	General Description of the SG-2000	1
1.2	Power Requirements	2
1.3	SG-2000 Performance Specifications	2
1.4	Data Communications	3
1.5	Computer Control of SG-2000.....	3
1.6	Multiple Control Head Specifications.....	4
1.7	Dimensions and Weight.....	4
1.8	Standard Features	4
1.9	External Accessories	5
1.10	Internal Accessories	5
2.0	Unpacking	7
3.0	History of the SG-2000	8
4.0	About the SG-2000	10
4.1	Receiver Signal Path	10
4.2	Transmitter Signal Path.....	11
4.3	Control Circuits.....	12
4.4	Control Heads.....	13
4.5	SG-2000 Front Panel.....	13
4.6	SG-2000 Rear Panel	13
5.0	SGC Family of Control Heads	14
5.1	Remote Mobile Heads	14
5.2	PowerTalk™ and PowerTalk™ SA	14
6.0	SG-2000 Software and Accessories	15
6.1	GPS Software	15
6.2	Oil Platform Software.....	15
7.0	Planning for Installation	16
7.1	Location of Power Supplies.....	16
7.2	Control Head Placement.....	16
7.3	Control Head Wiring.....	17
7.4	External Speakers.....	17
7.5	External Accessories	18
8.0	Radio Licenses	19
8.1	Station Licenses	19
8.2	Operator Licenses	20





9.0 Installation21

- 9.1 SG-2000 Rear Panel Connections21
- 9.2 External Coupler Installation22
- 9.2 External Modem, Weatherfax and High Seas Direct™23
- 9.3 Continuous Duty Ratings23
- 9.4 Rack Mount Kit Installation (Part No. 52-90).....24
- 9.5 Control Head Installations.....27
- 9.6 Remote Head Kit Installation (Part No. 04-12)27
- 9.7 Additional Control Heads (Part No. 04-11)28
- 9.8 Remote Head Cable Extension.....29

10.0 Power Supplies.....30

- 10.1 Cabling.....30
- 10.2 AC Power Supplies31
- 10.3 Transformer-Rectifier Supplies31
- 10.4 Mobile Power Supplies32
- 10.5 Solar-Powered Chargers33

11.0 Antenna Systems.....34

- 11.1 Antenna Wire Size35
- 11.2 Near Vertical Incidence Skywave.....36
- 11.3 Base Station and Fixed Antennas36
- 11.4 Antenna Feed Lines37
- 11.5 Antenna Couplers37
- 11.6 Mobile Antennas38
- 11.7 QMS Recommended for Mobile Use.....39
- 11.8 Unconventional Mobile Antennas.....40

12.0 Operating the SG-200041

- 12.1 Syntax41
- 12.2 Front Panel43
- 12.3 Push-Button Functions44
- 12.4 Sample Entries48

13.0 Tour of the SG-2000.....49

- 13.1 Front Panel Display49
- 13.2 Front Panel Controls.....52
- 13.3 Primary Keyboard Functions52
- 13.4 Shift Functions57
- 13.5 Program Functions.....59
- 13.6 Operating Session59
- 13.7 Channel.....60
- 13.8 Frequency61



13.9	Programming.....	63
13.10	Scanning Functions.....	64
13.11	Changing Frequency or Channel Scan Rates.....	68
13.12	Additional Functions.....	69
14.0	Mobile Installation.....	75
14.1	Shock and Vibration Mounting.....	75
14.2	Mobile Grounds.....	76
14.3	Vehicular Noise Sources.....	78
15.0	Marine Installation.....	80
15.1	Marine Radio Mounting.....	80
15.2	Marine Ground Systems.....	80
15.3	Marine Antennas.....	82
15.4	High Seas Direct™ Connections.....	82
16.0	Remote Control.....	85
16.1	Extension of Control Head Wiring.....	85
16.2	Short Haul Modems/ Auto-Answer Devices.....	86
16.3	Line of Demarcation.....	86
16.4	Auto-Answer Devices.....	87
16.5	Computer Networks - Serial Control.....	87
17.0	External Software.....	88
17.1	RS-232 Serial Control Software.....	88
17.2	RS-232 Software Installation.....	89
17.3	Main Menu Display.....	92
17.4	Main Menu Operations.....	93
17.5	Menu 2 Operations.....	95
17.6	Programming Functions.....	96
17.7	PC Cable Assembly.....	98
18.0	ALE and Adaptive Controllers.....	100
18.1	SG-2000 Serial Port Operation.....	101
18.2	Serial Communication Protocol.....	102
18.3	ALE Controller-Command Examples.....	103
18.4	Recall a Selected SG-2000 Memory Into Active Use.....	103
18.5	SG-2000 Connections to ALE Controller.....	104
19.0	Accessories 106	
19.1	Exsel-100 Selective Calling System.....	106
19.2	Telorex™ ARQ/FEC/SELFEC System.....	107



20.0 Answers to Frequently Asked Questions.....108



21.0 Technical Reference.....110

- 21.1 Squelch Scale Recalibration110
- 21.2 SG-2000 Microprocessor Reset Procedure.....110
- 21.3 Emergency Calling.....111
- 21.4 Basic Tune-up Procedure (Alignment)112
- 21.5 AM Filter Bypass.....113
- 21.6 Oscillator and Filter Operation113
- 21.7 Microprocessor Assembly115
- 21.8 VCO's115
- 21.9 PLL's.....115
- 21.10 Serial Logic Switches116
- 21.11 Tone Generator.....116
- 21.12 Oven Switch.....116
- 21.13 Alarm Generator116
- 21.14 Master Oscillator with Oven117
- 21.15 Crystal Oven.....117
- 21.16 Output Low Pass Filters.....118
- 21.17 Automatic Level Control118
- 21.18 Modulation Characteristics, AFR118
- 21.19 Modulation Characteristics, PEP Limiting.....119
- 21.20 SG-2000 Performance Measurements121

22.0 Trouble Shooting127

- 22.1 Dysfunctions127
- 22.2 Scanning in One Direction Only128

23.0 Test Procedures.....129

- 23.1 Exciter Testing Procedures129
- 23.2 LPA Testing Procedures.....156
- 23.3 Display Section Testing Procedures163
- 23.4 Head CPU and Main CPU Testing Procedures171
- 23.5 Final Assembly Testing Procedures178

24.0 Schematic Reference Section180

INDEX210

Appendix A, Frequency ListA-1



1.0 General Description and Specifications

This section includes a short description of the features of the SG-2000 Transceiver along with its specifications. This manual includes information useful for the SG-2000, the SG-2000 SlimPak, and the Military version (PRC-2250 MIL).

1.1 General Description of SG-2000

Model	SG-2000
Channels	100 channels field programmable 644 factory programmed ITU voice and data channels
Scan channels	Up to 100 channels programmable in 6 groups of 10 channels each
Scan frequency	In 0.1, 0.5, 1, 3, and 5 KHz steps
Scan frequency range	Full HF range or a selected range of frequencies
Scan dwell time	Adjustable from .1 to 40 seconds Frequency scan dwell: .1 to 1 second Channel dwell time: .2 to 40 seconds
Transmitter frequency range	1.6 to 30 MHz
Receiver frequency range	1600 KHz to 30 MHz (500 KHz - 30 MHz Optional)
Frequency stability	±10 Hz
Frequency resolution	100 Hz
Modes	A3A, A3H, A3J and CW in LSB and USB, True AM detector in receive mode. Data modes supported by external controllers.
Protection	Fully protected against damage due to battery reversal, over voltage, or antenna fault (open or short).
Display	LCD for frequency or channel with annunciators of all functions and modes, 20-segment bar meter, and time or date
Metering	S-meter in RX mode, forward power or VSWR in TX mode
AGC	Fast attack slow release in Voice mode. Extremely fast attack fast release in telex and ALE modes.
Keypad	21 push-buttons include power, up/down, all functions, and numeric entry



Alarm generator	Programmed for standard ITU and CCIR alarm on emergency frequency 2182 KHz or can be broadcast on any frequency. Having to press two push-buttons simultaneously to activate transmitter prevents accidental alarm.
Operating temperature	-45° to 85° C
Full specification temperature	-30° to 60° C
Approvals	FCC type accepted, parts 80, 87 and 90. DOC and CEPT(pending). Meets CCIR specification for receiver and transmitter* (see page 5)
Color	Black
Front panel	Splash proof, removable and may be mounted remotely

1.2 Transceiver Power Requirements

Nominal	13.6 VDC; 0.8A RX, 16A TX (voice)
Full specification compliance	11.5 VDC
Full operation	10.5 to 18.0 VDC
Current drain when radio off:	
STBY mode,	
Oven on;	430 mA
oven off;	80 mA

1.3 SG-2000 Performance Specifications

RECEIVER SPECIFICATIONS

Sensitivity	.5 μ V produces .5W of audio with 10dB SNR (Signal to noise ratio may vary from 7 to 16 dB at nominal .5 μ V input)
Selectivity	2.4 KHz at -6 dB; 4 KHz at -60 dB shape factor better than 2:1)
Intermodulation Blocking	+86 dB (CCIR specification)
Transmodulation	+100 dB (CCIR specification)
Image and IF rejection	+ 95 dB (CCIR specification)
Audio output	+90 dB
Audio distortion	4W with less than 10% distortion
	Less than 5% at 3W



AGC response	Less than 5dB variation at the output for 5 μ Volt to 1 Volt RMS at the receiver input
Clarifier range	\pm 600 Hz in 100 Hz steps
Receiver protection	Up to 50 Volt RMS at the receiver input
Squelch	Voice operated with syllabic detection – adjustable threshold
Speaker	Internal (on removable front panel)

TRANSMITTER SPECIFICATIONS

Power output in 50 ohms	150 watts* PEP (+0dB to -.5 dB) (see page 5)
Power output reduction	To less than 50 watts PEP
Maximum stress power output	225 watts CW*** (see page 5)
Sideband suppression Harmonic	Better than -50 dB at 1400 Hz
suppression	Better than -63 dB** (see page 5)
Carrier suppression	(A3J) Better than -55 dB
Carrier level	(A3H) -3 dB (A3A) -16 dB
Noise suppression	Better than -60 dB
Distortion (third order)	Better than -32 dB at 135W PEP
Audio response	Flat within 6 dB between 350 & 2400 Hz
VSWR protection	For 4:1 VSWR, power output will reduce below 50 watts PEP
Thermal protection	For 80°C power output will reduce below 50 watts PEP

1.4 Data Communications

Ready and compatible	RTTY, ARQ, FEC, PACKET and telegraphy
Receive/transmit switching time	10 mS nominal
AFSK input/output impedance	600?
AFSK input level	Minimum required 100 mV RMS, 2V RMS maximum
AFSK output level	240mV RMS at .5 μ V, maximum 1V RMS

1.5 Computer Control of SG-2000

Input/Output	RS 232
--------------	--------



Access and recall Software	Of all transceiver functions except audio SG-2000 for DOS (Supplied with C language source code)
System software	DOS Ver. 3.0 or greater for IBM and compatibles (user supplied)



1.6 Multiple Control Head Specifications

Local	One controller mounted to the radio (except SlimPak)
Remote	Up to 50 meters away from the radio (10 wires)
Intercom	On all remotes
Maximum number of controllers	8 (Total of control heads and computers not to exceed 8)
Telephone remote	Through standard telephone line and modem with telecommunication software and SGC-RS-232 software

1.7 Dimensions and Weight

Overall Dimensions	11.7 (H) x 25.4 (W) x 38 (L) cm 4.75 in. (H) x 10 (W) x 15 (L) inches (SlimPak 1" less in height)
Weight	5.4 kg (12 lbs)

1.8 Standard Features

- Full remote control, up to 8 stations
- Upper or lower sideband select
- A3A, A3H and A3J select
- Emergency 2182 direct select (Standard Head only)
- Voice or Telerex (narrow band) filter select
- CW side tone oscillator, CW with break-in
- Alarm Generator
- Speaker on/off, rear panel audio I/O port for modems, Weatherfax
- Headset/handset driver separate from speaker
- Carbon or dynamic microphone select switch
- Squelch on/off and level set
- Coupler tuned indicator
- 20 dB receive attenuator
- Transmitter power level set (50 or 150W)
- Transmitter over temperature indication and thermal protection
- Receive S-meter and transmit forward power or SWR meter display
- Time of day or date display
- Radio on/off timer
- Intercom with all stations or private channel select

1.9 External Accessories

- Marine antennas
- Vehicular antennas
- Whip antenna in 8, 23, 28 or 35 ft. lengths
- SG-103 broadband antenna, 2-28 MHz
- SG-103-T tactical broadband antenna, 2-28 MHz
- Dipole antenna for 1,2 & 3 specified frequencies
- Field adjustable dipole antenna
- SGC Portamast
- SG-230 150 Watt MicroProcessor controlled antenna coupler
- SG-230 Pro 150 Watt MicroProcessor controlled antenna coupler
- SG-235 500 Watt MicroProcessor controlled antenna coupler
- PS-30 power supply for base station (unregulated)
- PS-35 power supply for base station (regulated)
- Standard mounting tray
- Shock mounting tray for high vibration installations
- Battery cable
- External speaker
- CW telegraphy key
- Dynamic desk and noise canceling fist microphone
- Military handset (waterproof, dustproof, shock-proof)
- Telephone handset
- Tel-Two phone patch
- Linear power amplifiers, 500 & 1000 watts output
- Front panel customizing
- TELEREX ARQ, FEC and PACKET systems
- ALE adaptive controller

1.10 Internal Accessories

- High power CW continuous fan kit
- ALE (Automatic Link Establishment) AGC switching (Specify at time of order)
- Special Software options: Hong Kong, France (and Territories), Oil Platform

Notes: * CFT8DK SG-2000 (1.8 to 26 MHz international radio marine bands)
** For international marine bands



*** Under ambient temperature and normal load conditions

**DO NOT ATTEMPT TO TRANSMIT UNTIL THE
RADIOTELEPHONE IS WARMED UP FOR AT
LEAST TEN MINUTES.**

The crystals that control the operating frequency are contained in a precision oven that requires 10 minutes to rise to the correct temperature. Transmitting before the 10 minute warm-up period has elapsed may cause a violation of FCC regulations.

Precautions:

- 1. Operating and installation personnel must observe all applicable safety regulations at all times. Do not operate unit without covers in place with power on. Under certain conditions, dangerous electrical voltages may exist. To avoid injuries, always confirm removal of power and discharge and ground all circuits before touching them.**
- 2. Do not service or adjust equipment when alone. Under no circumstances should you reach into live equipment for the purposes of adjustment or servicing unless there is someone else present who is capable of rendering aid.**
- 3. Personnel working with or near AC power sources, power supplies and high power radio equipment should be familiar with modern first aid techniques and resuscitation.**
- 4. When servicing, observe static discharge precautions to avoid damage to microprocessors and solid state devices.**
- 5. When servicing multiple control head installations, disconnect all remote heads at J-503 on the rear panel of SG-2000 to prevent other personnel from keying the transmitter during servicing.**

SGC reserves the right to change specifications without notice.

2.0 Unpacking

The standard packaging for an SG-2000, the cardboard box and packing materials, should be retained for future use should the radio need to be shipped elsewhere.



Please note that the radio arrived in a polyethylene bag which includes the instruction manual, warranty registration card and a quick reference card. Information on use of AT&T High Seas services is also provided for your convenience. The plastic bag protects the unit from dust and moisture when shipping. If there is condensation on the inside of the polyethylene bag because the radio was subjected to extreme change of temperature during shipment, please leave the plastic covering on the radio until it has come up to ambient temperature and the condensation has evaporated.

You will notice a piece of foam rubber on the face plate of the radio, held in place with tape. It is designed to protect the plastic face plate of the LCD. Whenever you are shipping an SG-2000, it is good practice to secure a cover over the LCD. Small scratches in the face plate of the LCD may be removed with Plexiglas™ cleaner such as is used to clean aircraft windows.

The SG-2000 should be closely inspected upon arrival. As the units leave the SGC factory, they are in perfect operating condition. Should you notice any bent sheet metal, or flecks of paint in the shipping box, you may assume that the radio has taken a hard shock somewhere in shipping.

The radio will usually continue to operate, even if subjected to abuse in shipping, but please make sure that if you notice any shipping damage, you file a damage report immediately with the carrier.

In the unlikely event that your unit has been damaged in shipping, your dealer can instruct you on how to handle servicing or replacing the unit. If your dealer does not know the proper procedure, you may contact SGC directly.

SGC provides a complete five-year parts and labor guarantee. However, this guarantee does not apply to radios which are used in para-military and military operations, as combat conditions are specifically excluded from our guarantee.

3.0 History of the SG-2000

The SG-2000 is a high performance, microprocessor (computer) controlled multi-mission HF SSB radio designed to meet the needs of marine, commercial, para-military, and amateur radio users through the year 2000 and beyond.

The SG-2000's heritage includes the SG-705, the world's smallest commercial HF SSB, the SG-715 waterproof manpack radio, and the SG-712 EX-11 which has been proven in commercial and military applications in all regions of the world.

The SG-2000 also benefits from SGC's expertise in microprocessor design, developed as the company evolved its line of fully automatic antenna couplers. SGC's fully automatic antenna couplers have been available since 1975 and the current computerized SG-230 series of couplers has been continuously upgraded to maintain technical dominance through software enhancements.

The SG-2000 was conceived by SGC President Pierre Goral and the SGC Engineering staff to meet an emerging need in HF communications for a relatively low cost, highly reliable yet flexible communications platform which would be suited to multiple control-point operation and would allow complete computer control if desired.

This was done after a careful study of emerging HF radio technology in the military and government sector and with an eye to providing the users of SGC equipment with the highest level of flexibility, not only today but in the future as well.

It was clear from the SGC analysis that to an increasing degree, personal computers would be integrated into mobile, fixed, and sea going radio operations. In addition, a whole new field called Adaptive Controllers was being developed for government and military use.

The SG-2000 design project became an all-consuming effort among the team members who studied all available information in order to provide a radio which would meet modern communications needs. The process was to collect and analyze all available trend information, review not only cutting edge but projected technology, and then build the radio that would meet all of these needs.

It is interesting to note the design team's criteria:

- The ideal radio would weigh as little as possible, under 6 kilograms would be ideal. The radio would need to operate from any location. This meant telephone line control for control at distances of several thousand miles, or by hard wire



control for local use at short to moderate distances.

- This radio would need to be controllable by a computer or its own control heads and it would have to support control from up to eight locations all at the same time. It would also be nice if the radio could be directed through a local area network with one computer on the network operating as a gateway.
- In addition, the eight locations would have to be connected via an intercom, the radio would need to be of high physical strength, and would be able to operate over extremes of temperature and humidity.

The SG-2000 would also have to meet exacting performance standards for frequency stability and for speed of operations in order to accommodate some of the more exotic demands of the para-military and military markets.

The result of the design effort is the SG-2000, the world's first truly computer-directed civilian radio. Many of the attributes of the SG-2000 can be found in very expensive military units, some costing 10 times the price of an SG-2000 and not generally available to the public.

In 1992, SGC introduced a ruggedized version of the SG-2000 designed for para-military use called the PRC-2250 MIL. This radio features many SG-2000 options ordered by (para) military organizations. It is finished in an olive drab color and comes with a military type shock mount with a waterproof handset standard, which distinguishes it from the SG-2000 in appearance.

In 1994, SGC introduced a SlimPak version. The SlimPak has all the features of the SG-2000 and uses the same control head; yet the main unit measures a full 1 inch less in height, enabling placement in much tighter quarters.

In 1995, SGC introduced a new model of the SG-2000 control head called the PowerTalk™ that incorporates ADSP™ and SNS™ noise reduction and noise filtering capabilities.

4.0 About the SG-2000

The basic SG-2000 is really two units, which may be easily separated. One unit is what is called the Radio or RF unit. This contains the receiver and the transmitter's exciter and linear power amplifier modules. In addition, it contains the SG-2000's main microprocessor.

The second unit, normally supplied attached to the radio unit, is called the control head. In it are audio amplifiers, the radio's frequency and channel displays, a keyboard to control radio functions and another microprocessor which "talks" to the main radio unit.

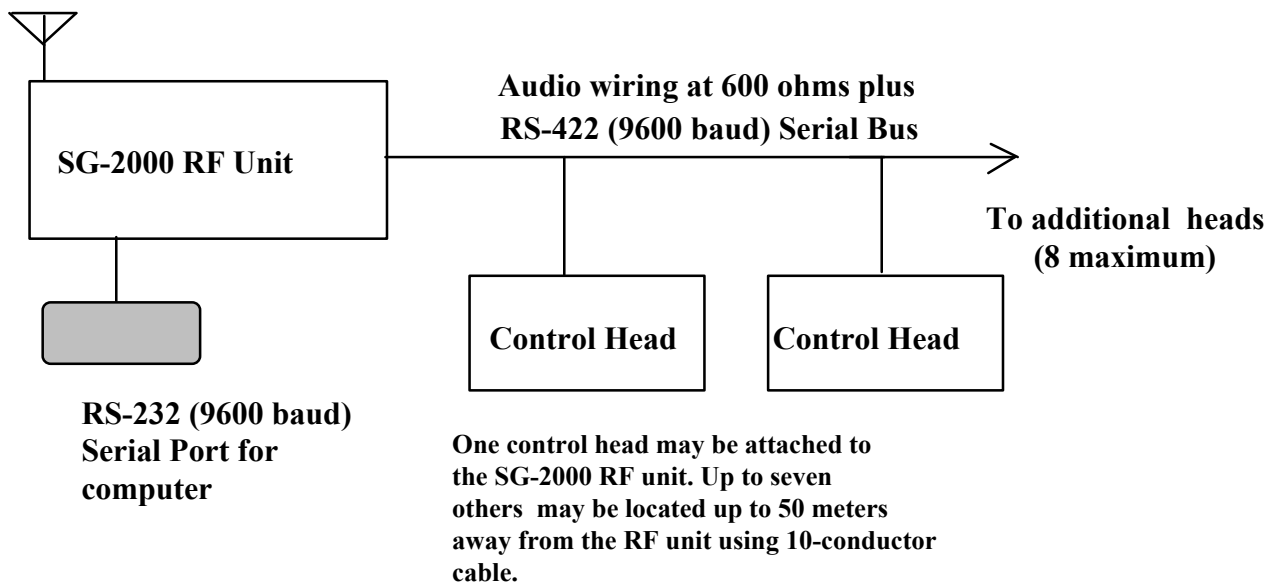

4.1 Receiver Signal Path

The receiver section, located in the main radio unit, features signal up conversion (from 82 to 88 MHz) to achieve maximum image rejection and to allow wide band processing of signals. Then the signal is converted down to 10.7 MHz where an extraordinarily sharp crystal filter removes all unwanted signals, including strong unwanted signals which have not been eliminated by the 82-88 MHz filters.

The 10.7 MHz signal is further amplified and is then decoded by one of the two detectors in the radio. For single sideband, CW (Morse Code), and data operations, a product detector is used. For AM, the SG-2000 provides one of the few "true AM" detectors available today. This provides for extremely clear reception and excellent



capture of signals in all modes.



Once amplified to a standard level, the audio is sent to a jack on the back of the SG-2000 which allows for connection to a control head. In the control heads, the audio signal is further amplified and processed.

A syllabic squelch circuit (which was pioneered by SGC in 1976) is used to turn off the noise coming out of the speaker in the event that a signal is not being received.

The next step is a digital gate which controls the volume of the receiver by very rapidly sampling the signal and passing only a certain number of samples – a number which varies by the setting of the volume control on the front panel of the radio. Naturally, this happens at speeds which you can not hear, so your ear hears smooth control of the volume function.

4.2 Transmitter Signal Path

Pressing the push to talk button grounds the push-to-talk line, placing the SG-2000 in the transmit mode. At the same time, the sound of your voice is shaped by an audio amplifier in the control head. This is brought up to a standard level to be sent out the transmit audio bus.

This line leaves the control head via the 10-conductor control head cable and returns to the SG-2000 RF unit via the rear panel connector where the head plugs into the rear panel of the radio.

Inside the radio, the audio signal is shaped and amplified. It is turned into an AM signal which is then processed to remove the desired amount of carrier. This is accomplished by a balanced modulator. In the single sideband mode, all of the carrier is removed. If required, the carrier is reinserted for other modes.

In the AME (AM Equivalent) mode, 40-50 W of the carrier is reinserted. And if you are operating in the A3A mode which is used for certain kinds of commercial radio work, then you put back about 1/8th of the carrier, leaving just enough of the signal to act as a "pilot carrier" for specialized receivers.

Next, the signal is amplified and passed through a crystal filter, where one sideband is removed. This is done by offsetting the transmit frequency slightly. On one side of the filter slope, the upper sideband is removed, while offsetting on the other side of the 10.7 MHz filter will remove the lower sideband.

When you are in the single sideband mode, you have now developed either the desired upper or lower sideband filter at this point. From here on, the amplifiers which will be processing the signal are called "linear amplifiers" because if they are not linear, they will distort the signal, just like a non-linear audio amplifier would distort a signal on your home stereo.

The 10.7 MHz single sideband signal is then converted up to 82-88 MHz, where harmonics are eliminated by the helical filter. The output of the 82-88 MHz filter is



mixed with the correct frequency developed by the synthesizer and is then amplified at the operating frequency.

This amplification process involves several steps: a pre-driver, a driver, and a final amplifier section which utilizes a splitter - combiner circuit

The pre-driver and the driver sections are very straight-forward in design. But the final LPA (Linear Power Amplifier) deserves special note because it is very conservatively constructed. This amplifier is made up of four transistors. While most designers will use only two, SGC elected to use four for reliability and peak power performance.

Controlling the LPA is a circuit called ALC (Automatic Level Control) which adjusts the operating conditions of the final amplifier to insure its operation is linear over a wide range of conditions.

A broad band filter network then matches the high power signal to a 50 ohm output impedance. This is then sent to the SG-230 Smartuner (which we highly recommend) or a broad band antenna system such as the SG-103.

4.3 Control Circuits

The SG-2000 is a microprocessor controlled radio. Each of the control heads has a microprocessor and talks to the microprocessor in the radio unit using the RS-422 communications protocol. This means that the control head may be placed as much as 50 meters away from the radio. Although not supported by SGC, many users of the control heads have reported success at longer distances. As with all SGC specifications, 50 meters is a conservative number.

The microprocessor control codes, which are generated when the front panel push buttons are pushed, are sent to the microprocessor in the radio unit which return confirmation to the control head that the instructions have been acted upon. The head microprocessor controls the display information and functions such as setting of volume and squelch levels.

Each of the control heads has a unique device address which allows the microprocessors in the radio unit to send information as well as establish the intercom address of the control head.

In the event that you wish to address the microprocessors on the radio unit directly, you may use the RS-232 serial port which is located on the rear panel of the radio.

Any number of serial ports and heads may be used, as long as the total number of device addresses does not exceed eight. Four control heads and four computers works as well as one control head and seven computers.



For more information on controlling the SG-2000 via computer, see Section 16.5 of this manual regarding "Computer Networks - Serial Control" and the parts of Section 17.0 dealing with RS-232 software.

4.4 Control Heads

There are several design considerations behind the SG-2000 control head which you should know about in order to appreciate the beauty of the architecture of the radio.

Our many years of manufacturing experience have taught us the value of absolute reliability and of the importance of easy reparability in the field. Such philosophies as designing in a 10-conductor control cable between our radios and remote heads rather than a fiber optic cable is one example. SGC has learned that while fiber optics are an excellent material, they are not easily repairable in the middle of the desert or ocean. SGC products are designed for field repair and performance where well-engineered products dramatically become evident.

4.5 SG-2000 Front Panel

The front of the SG-2000 controls all radio functions. All of the push buttons are rubberized to provide good tactile response and to keep the radio highly resistant to water and dust, two of the worst enemies of electronic equipment.

The LCD which displays the frequency is the largest available on a radio of this type. The speaker is treated to resist moisture. The speaker grill is designed to prevent direct spray from hitting the speaker.

Because the front panel has been ruggedly built, the advantage of mounting the more sensitive radio unit elsewhere becomes apparent.

4.6 SG-2000 Rear Panel

A series of Jacks on the back of the SG-2000 provide access to radio features and accessories. Most of these jacks are covered by a metal "U" bracket which is held in place by three small Phillips head machine screws. If you ever have occasion to remove this cover, it is important that it be replaced in order to provide physical protection for the jacks.

Under the "U" bracket, from left to right, you will find a jack to plug in one of the family of SGC's Smartuners. The next plug (J-301) presents audio input and output lines, plus push-to-talk control. This is where Weatherfax, data controllers (such as an SGC Telerex™ SITOR modem), and ALE units are plugged in.

The next two jacks are for plugging in two control heads. If you are using more than one control head, one will plug in to the right hand head plug while a multiple plug adapter unit plugs into the left control head jack and provides for up to seven additional head connections.



The last jack, J505, is used for connecting an external speaker. This is also the most common connection for the Weatherfax.

In addition, just to the right of the "U" bracket is an RS-232 connector for computer control of the SG-2000 radio, as explained later in this manual.

5.0 SGC Family of Control Heads

The SG-2000 comes with the standard control head described throughout this manual. In addition, there are six other control heads to choose from. These range from the small remote mobile heads to the new PowerTalk™ head incorporating ADSP™ and SNS™ noise reduction capabilities.

5.1 Remote Mobile Heads

The four models of the remote mobile heads are designed to be used in conjunction with the SG-2000. They have simplified control functions and a much smaller footprint. They include the basic version, the aircraft version, the Exsel version and the remote mobile head with ADSP™ noise reduction.

Please contact SGC for information on any of these optional heads.

5.2 PowerTalk™

Another optional control head is our newly released PowerTalk™ head. The PowerTalk™ head is the same size as the standard remote head but with more versatility, including the additional benefit of state of the art noise reduction circuits to let the user filter out unwanted noise.

Please contact SGC for information on this model.

6.0 SG-2000 Software and Accessories

This section lists various software options that are available for the MicroProcessor controlled SG-2000. In the event that you own an SG-2000 and later wish to add different software, such as the GPS software, Oil Rig software, Hong Kong software, or other software as may be periodically published, please be advised that there is a software update charge if the software is retrofitted into an existing radio.

6.1 GPS Software

Effective April 1, 1992, a special edition of the SG-2000 main microprocessor software was published to meet the needs of the oil and gas exploration industry for a radio which would not search the international emergency frequency, 2182 KHz, when the radio is first turned on. The special software is now standard.

In addition, the SG-2000, which was adapted to differential GPS radio location service in January of 1992 has special cooling modifications which allow it to operate under severe service for unlimited time. The additional cooling systems may be ordered by users who anticipate extended key down operations, including differential GPS, ALE, SITOR/AMTOR/RTTY, and other data modes or plan to subject the SG-2000 to unusually warm operations (such as desert vehicle installations).

6.2 Oil Platform Software

In May 1992, special software became available for the main MicroProcessor of the SG-2000 which will allow the transmission of an emergency distress tone on all frequencies, removing the normal limit of transmitting on only the international emergency frequency, 2182 KHz. This was done at the request of oil exploration companies who have been using the SG-2000 successfully in offshore oil exploration work and who are required, because of international regulations, to both test and operate their emergency distress beacons on frequencies in addition to the international 2 MHz band channel. This software is now standard on the SG-2000. Press the shift function and emergency buttons at the same time and the distress tone will be transmitted on the displayed frequency.

Effective September 1, 1992, a special edition of the SG-2000 became available to users of the SG-2000 in Hong Kong. Certain radio programming features are deleted in order to meet Type Approval requirements of Hong Kong's G.P.O.

7.0 Planning for Installation

Before installing the SG-2000, some pre-planning based on the capabilities and features of this radio should be undertaken to ensure the best possible performance.

7.1 Location of Power Supplies

If you are installing your SG-2000 in a normal environment, such as a radio room of a ship or in a room of an office building or home, placement of the power supply is not critical as long as it is placed within 25 feet of the radio.

If you are installing the radio in a small boat, such as a cruising sailboat or an offshore fishing boat, you may wish to consider an additional gel cell (sealed) battery for radio operation. In this way, should the vessel take on water during a storm, the radio will continue to be operational.

A good way to install such a system is to place the "radio battery" in the vicinity of the radio and place an isolator between the radio battery and the rest of the battery system. When connected to the vessel's main batteries, the radio battery will prevent the voltage drop which may develop on long cable runs and will assure peak radio performance.

7.2 Control Head Placement

One of the advantages of SG-2000 / PRC-2250-MIL ownership is that control heads may be placed anywhere within 50 meters of the radio unit. This provides a high degree of installation flexibility. Consider some of the more common civilian uses.

Marine. On a vessel, you may want to have a control head located at the bridge, navigation station, in the cockpit of the vessel and perhaps in staterooms. If you are planning extended cruising on a typical ocean-going sailboat, usually two heads are planned, one at the navigation station and another in a watertight case in the cockpit. This is because in most serious ocean cruising, the owner's stateroom is not used as often as the navigator's quarter berth, usually located very close to the navigation station.

Mobile. Installation in a mobile environment is something else. If you are the only radio operator on a small four wheel drive vehicle, such as a Chevrolet Geo Tracker, which we use as a test bed for mobile systems, you will likely have a single control head and this would be mounted on the dashboard using the 5-way suction cup mount.

If your mobile installation is larger, as in a bus or large recreational vehicle, you may wish to have one control head in the rear area and another control head in the vehicle

cockpit.

Aviation. Installation on aircraft presents an unusual challenge. In most cases, the control head is mounted separately from the radio. This allows the radio unit to be placed very close to the aircraft center of gravity.

7.3 Control Head Wiring

The control head cables which are used with the SG-2000 are designed for use in normal conditions. This means that the cables are suitable for use in mobile and fixed installations. Very high vibration environments and mounting in military situations require special precautions.

In high vibration environments, wire chaffing must be avoided. Although it will take more installation time, secure all wiring tightly to prevent movement. Once movement begins, the protective covering of wiring can be quickly worn away. This is especially true on a tug boat, for example, where vibration caused by the ship's large propeller can cause 1/8" to 1/2" vibration and rates of 10 cycles per second or more. A shaking control head wire moving even a fraction of an inch as it passes through a clamp will ultimately fail.

Military installations require a different approach. The danger here is not vibration but shrapnel. The most common methods used are either to bury the cable in a trench one half meter deep, or, if the ground is hard or rocky, to place one or more layers of sand bags over the cable.

7.4 External Speakers

The SG-2000 has no separate front panel headphone jack because the radio front panel is weather-resistant and a headphone jack is just another hole that reduces the weather resistance of the control head.

If you plan to use high impedance headphones, such as the type included in a telephone handset, you will connect these to the radio via the microphone jack. On the other hand, use of a low impedance headphone requires the use of the external speaker jack, which is present on the rear panel of the SG-2000 main unit. The J-505 jack, the external speaker jack, is also where a low-impedance Weatherfax modem may be connected.

The speaker jack on the rear of the SG-2000 is controlled like the front panel speaker. In other words, when the SPK (speaker) is disabled on the control head, the remote speaker which is wired in parallel with control head #1 speaker is also turned off.

Important Note: The rear panel speaker is only available when the control head of the SG-2000 is attached to the radio. This is because a separate speaker audio line is run from the attached control head (where the audio amplifier is



located) to the rear panel. When the head is detached, this wiring is no longer available.

7.5 External Accessories

External accessory location should also be part of the planning process. If you are planning to add external equipment such as a Weatherfax receive modem, a terminal node controller (TNC) for amateur use, a commercial standard SITOR modem, such as the SGC TELEREX™ system, or an ALE controller such as the SGC HardLink™ System, provision for the mounting and operation of these items should be made at the time of installation.

When planning the use of an external audio input to the SG-2000, make provision for switching the external audio source on and off. This is necessary because the external audio input feeding the SG-2000 is an unswitched bridge. In order to avoid transmitting a microphone and line input signal (via J301) at the same time, you must be able to turn off the line input source.

If you are planning to use some external units, you may need to plan additional space for peripherals which may be required. As an example, the ALE controller requires a video display terminal (or IBM-PC type computer) to access programming. This may be a single unit terminal and keyboard, or it may be discrete keyboard and display units.

A TNC may require a printer, a computer, or both. Provision for mounting of these items is a good idea, especially if you will be adding them in the future.

Because of the larger number of options available, the subject of external radio peripherals is covered in more depth later in this manual.

Look ahead – and plan for your future needs before you begin your installation!

8.0 Radio Licenses

Finally, before we discuss installation of the SG-2000 radio, we should discuss licensing. The operation of an SG-2000 generally requires two types of licensing. In the United States, both a station license and an operator permit are issued by the Federal Communications Commission. The SG-2000 is type accepted for use on both U.S. marine and amateur bands. Therefore it is exempt from Part 97.11 (b) regulations requiring separation of marine and ham radio equipment. Part 97.11 (b) prevents ham radio equipment from being used on commercial bands but does not preclude use of type-accepted commercial equipment on the ham bands.

8.1 Station Licenses

The U.S. F.C.C. issues licenses for the operation of many classes of radio stations. This includes ham radio stations, commercial marine shore stations, shipboard stations and those involving various kinds of mobile applications such as HF systems aboard aircraft. There is an exception, however. Stations operating under the auspices of the U.S. military and stations in the Military Affiliate Radio System (MARS), are exempt from the licensing requirements of the F.C.C. but are subject to military rules. Most countries have comparable regulations.

Generally, the charge, if any, for filing a station application is modest. If you are planning to operate a U.S. commercial radio station, such as one aboard a fishing boat, simply call the F.C.C. Regional Office (there are 12 regional offices located in the U.S.) and ask them to send you the appropriate paperwork. Outside the U.S., check with government authorities.

The same goes for pleasure craft such as cruisers, sports fishing boats, and sailboats. The definition of "commercial station" means that the radio can be used for conduct of "business."

It is generally a simple process to fill out the application form for a commercial license. You may find that you will be asked for the SG-2000 Type Acceptance number. This is not the model number of the SG-2000. It is the F.C.C.'s unique identifier which references the official testing and approval paperwork.

On the license application, where "Type Acceptance Identifier" is requested please fill in the following:

CFT8DKSG2000



If you do not plan to operate aboard a ship, but have a need to communicate with vessels on a regular commercial basis, you may qualify for a private coast station license. The U.S. F.C.C. also has licenses available for specialized needs such as long distance aviation communication.

In the United States the use of a commercial SSB station on land to communicate with vessels is not allowed without proper licensing. To make application for a U.S. shore station, you will need to complete F.C.C. forms 503, 155, and 753. The filing fee as of 1995 for form 503 is \$120 while the filing fee for form 753 is \$45. There is no charge for form 155, which is a form to list your filing fees. This type of license is recommended for marinas and fisheries services.

If you have a touch-tone telephone, you may order the appropriate license application forms from the F.C.C.'s automated telephone forms request service through your local office. The telephone number to call in the United States for current fee information is (202) 418-0220.

A current printed copy of rules and regulations governing commercial marine operations is available from Fair Press Services, P.O. Box 19352, 20th Street Station, Washington, D.C., 20036-0352. Their phone number is (202) 463-7323. There is a charge for this publication.

Amateur (ham) radio may not be used for the conduct of business and the operator of the radio station is also licensed to repair the equipment. A test must be passed in order to secure a ham radio license. Commercial stations may be serviced only by a person holding the appropriate class of commercial radio license.

8.2 Operator Licenses

In the U.S., a radio operator license is required. The person operating a commercial station aboard a pleasure craft, or any ocean going vessel under a certain tonnage, must have at least an "Operator Permit" to use the radio of an appropriately licensed vessel.

It is simple to obtain the commercial Operator Permit document. It constitutes an agreement to use the radio properly, use no profanity and to use the radio for no illegal purposes. You sign your name, give your mailing address, and a few weeks later, an operator license arrives.

If you intend repairing commercial radio equipment, the requirements become stringent very quickly. A General Class Radiotelephone License is required to make adjustments of equipment used in commercial service.

The F.C.C. has reduced the Morse Code requirements of a ham radio license and the SG-2000 may be operated in the 10 meter amateur band with the new "Code Free" license. Information about becoming a ham radio operator in the U.S. is available by calling the National Amateur Radio Association, NARA, which maintains a toll-free (800) telephone number.

9.0 Installation

Your SG-2000/PRC-2250-MIL will provide superior communications under all conditions if you take the time to plan and install the radio equipment for maximum performance. Please read this section very carefully and implement as many of the suggestions as possible to assure a trouble free installation, a superior transmit signal, and clear reception.

This section of the manual will cover:

- General installation information and pin outs
- Control head installation and remote kits
- General comments on power supplies and antennas
- Specific mobile installation notes
- Specific marine installation suggestions

9.1 SG-2000 Rear Panel Connections

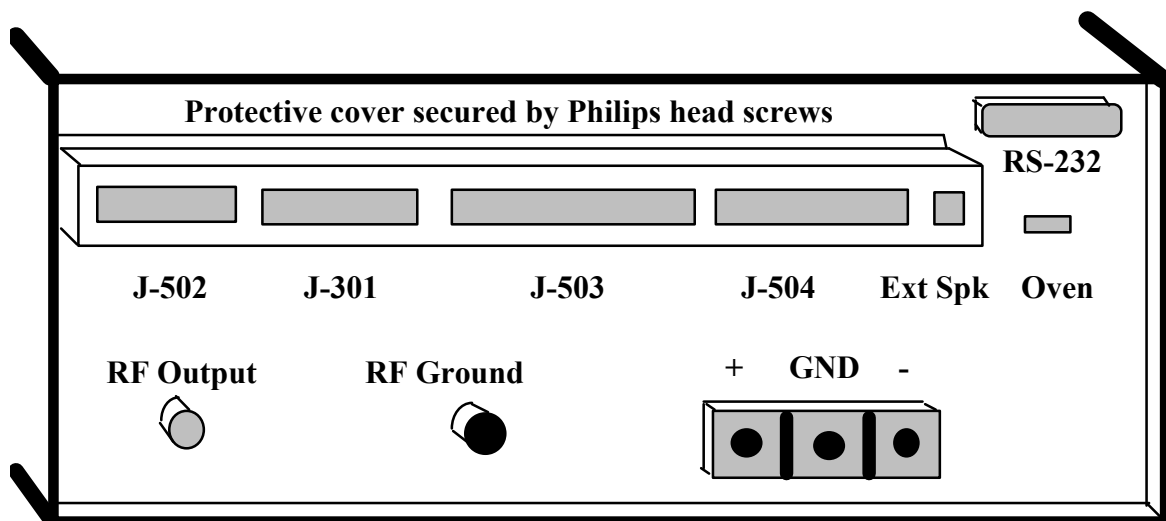

Please note that your SG-2000 is shipped with all necessary connectors for the addition of one of our Smartuner™ couplers and for installation of peripherals via the audio input/output jack on the rear panel. You will see the connectors when you loosen the Philips head screws which hold the protective sheet metal cover over the rear panel connectors and remove the cover.

From left to right, these jacks provide the following:

- J-502** SG-230/SG-235 Smartuner™ connections
- J-301** Aux. Audio input/output and PTT line
- J-503** Remote control head or multiple head junction box
- J-504** Remote control head or multiple head junction box (Head mounted on radio is normally connected here.)
- Ext Spk** External Speaker (or Weatherfax modem)
- Oven** Turns oven On-Off (Shipped with oven ON as default)

Pin outs of the external coupler jack and the Audio Input/Output jack are listed below. These may also be found in the SG-2000 Technical Reference in appropriate schematics.

9.2 External Coupler Installation

Connector J-502 is used to connect the SG-2000 to an external coupler. Details are shown in the diagram below:

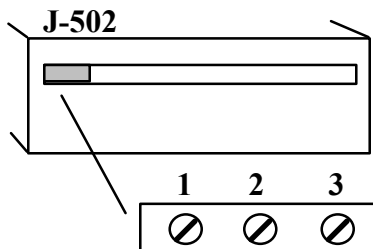

Coupler Connections on rear panel of SG-2000

- J-502 Pin 1: Coupler Ground. (Black wire from SG-230/SG-235)**
Pin 2: Coupler +12 VDC. (Red wire from SG-230/SG-235)
Pin 3: Remote Tuned Indicator (Black/White wire from SG-230/SG-235)

Do not connect the Red/White wire from the SG-230/SG-235 as this wire is used to control coupler functions. See SG-230/SG-235 manuals for details on coupler control options via this wire.

9.2 External Modem, Weatherfax and High Seas Direct™

Connector J301 is used to connect the SG-2000 to an external modem. Details are shown in the diagram below:

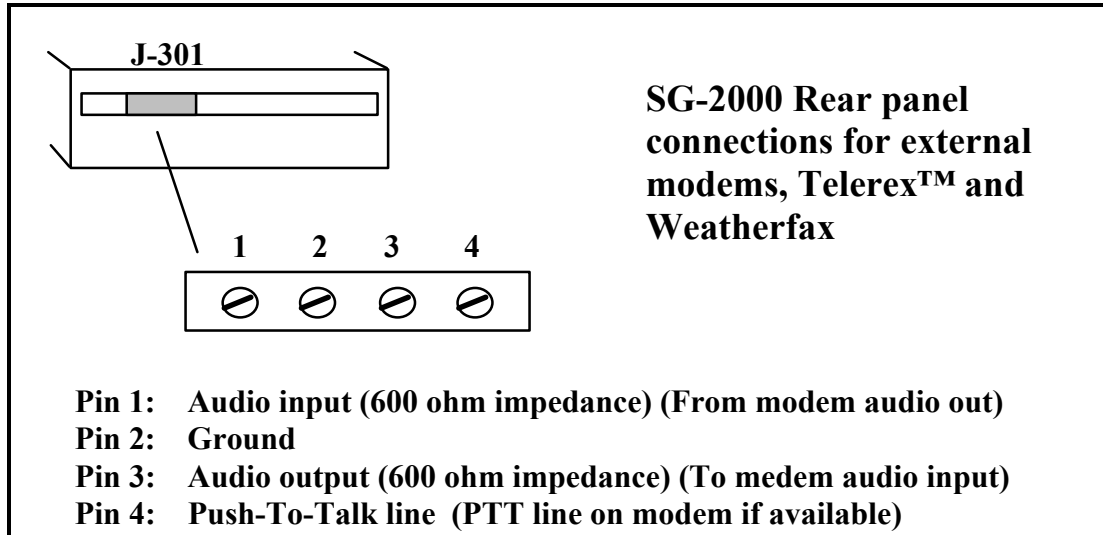

Weather fax modems: Connect Ground from modem to Pin 2 and audio input to modem to Pin 3 of J-301. (Weather fax modems may also be connected to the external speaker jack.) See Appendix for High Seas Direct connections. See page 61 for connection to ALE controller and serial devices.

9.3 Continuous Duty Ratings

If you are planning to use your radio for intermittent voice communications, continuous duty ratings are of no consequence. However, if you are planning to transmit for long periods of time on a frequent basis, you should consider the duty cycle and continuous ratings of components, ordering heavy duty cooling options if necessary.

Duty cycle is a simple concept. If you are dealing with speech and you will be transmitting about one quarter of the time, then the duty cycle of equipment is about 50%. However, if you are planning extended broadcast of information, speaking or sending hours of information such as using a transceiver in the ARQ data transmission mode, then continuous duty ratings are required.

All SGC equipment is conservatively rated. We use commercial service ratings for all of our equipment and make continuous service available upon request. Continuous Service is primarily a matter of adding additional cooling to a unit, as heat is the culprit in most component failures when equipment is used in continuous service.

SGC Part Number 51-81 is an internal fan option which consists of a muffin type fan which is controlled by a temperature sensor inside the radio. With the fan on, air enters the bottom of the radio and is exhausted through a special louvered top cover and slots on the rear panel.

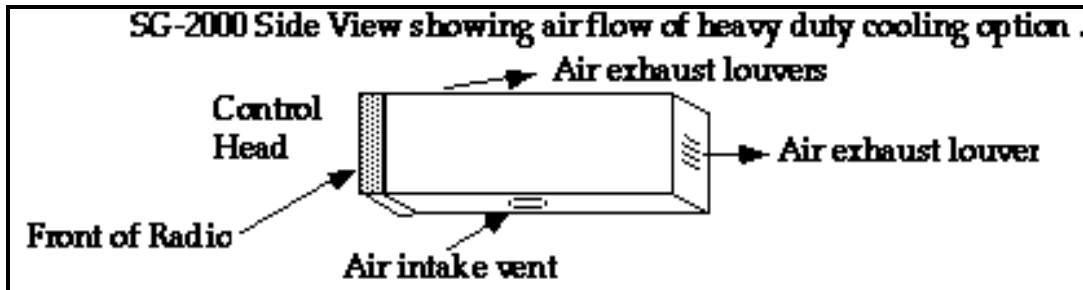

When using the continuous duty option on the SG-2000, power output is limited to 110-120 watts continuous. Maintain an unrestricted air flow area of at least 1 inch around all surfaces of the radio.

SGC Part Number 52-90 (Rack mount kit for SG-2000) has fans built in and is also suited for continuous duty operation. Field installation instructions for the rack mount follow.

Note: If you are using your SG-2000 in continuous duty operation, you must be certain that the power supply you plan to use is suited to continuous operation. We recommend the SGC PS-30 or PS-50 power supplies, Part Numbers 53-04 and 53-05, for continuous duty commercial service.

9.4 Rack Mount Kit Installation (Part No. 52-90)

The SG-2000 may be mounted in a standard 19" equipment rack. This installation may be performed in the field using the following procedure:

TOOLS REQUIRED:

- Philips Screwdriver #2 Point
- Philips Screwdriver #1 Point
- Nut Driver 1/4"
- Flat Blade Screwdriver 1/8"
- Nut Driver 5/16"
- Open End Wrench 1/4"
- Flat Blade Screwdriver 3/8"
- Open End Wrench 7/16"



TEST EQUIPMENT REQUIRED: None

CAUTIONS:

- **Power must be disconnected from radio.**
- **Do not over tighten screws which will strip heads.**

Installation Procedure

1. Remove top cover-secured by six black #6 Philips Head screws-set cover and screws aside.
2. Remove bottom cover-secured by six black #6 Philips Head screws-set cover and screws aside.
3. Remove rear panel connector cover-secured by three #4 Philips Head screws-set cover and screws aside.
4. Remove rear panel control head cable clamp-secured by one #4 Philips Head screw-set screw and clamp aside.
5. Unplug control head cable connector (10-position) from rear panel.
6. Remove control head as follows:
 - a. Remove two #6 Philips Flathead screws from either side panel (located towards front of radio)
 - b. Remove two #6 Philips Flathead screws from other side panel (located towards front of radio)
 - c. Lift control head cable up and out of cable U-Channel.
 - d. Gently pull control head/cable assembly forward-set this assembly aside.
7. Install the fan option connector assembly supplied by plugging the connector into J16 with the Green wire to Pin 1.
8. Set the radio (upside up) into the tray assembly. Rear of radio should face power cables.
9. Lift the rear of the radio (if necessary) and install the DC power wires to the radio DC terminal strip; red to "+", black to "-" set radio back down (if necessary).
10. Secure radio to bottom cover. Use four #6 black Philips Head screws removed in step #2.



11. Install RF ground jumper braid onto radio rear panel RF ground bolt.
12. Install RF coax jumper into radio rear panel RF in/out connector-set the radio/tray assembly aside.
13. Install the control head rear panel as follows;
 - a. Unplug the control head cable connector (10-position) from the control head display board assembly-set the cable assembly aside.
 - b. Remove either head mounting bracket by removing two Philips Head screws.
 - c. Remove other head mounting bracket by removing two Philips Head screws.
 - d. Install the four longer threaded stand-offs, SGC part # 965-913 (supplied), into the inserts from which the screws were removed in steps B and C above.
 - e. Replace four #4 Philips Head microprocessor assembly mounting screws with the four shorter threaded stand-offs, SGC part #965-908 (supplied).
 - f. Remove control head connector (10-position) from control head cable.
 - g. Pass the control head cable through the Heyco watertight fitting on the control head rear panel (supplied). Do not tighten the Heyco.
 - h. Re-install connector removed in Step F (see illustration supplied).
 - i. Install control head connector onto control head display board assembly (from step A)
 - j. Attach control head rear panel to control head using eight #4 Philips Flathead screws (supplied).
 - k. Tighten Heyco
17. Attach control head assembly to rack mount front panel using four each #8 nuts (supplied attached to control head rear panel).
18. Attach control head/front panel assembly to tray assembly using 7 each #4 lock washers and #4 nuts (supplied attached



to front panel)



19. Re-install control head cable connector (10-position) into rear panel (from step #5)
20. Re-install cable clamp using one #4 Philips Head screws (from step #4).
21. Re-install rear panel connector cover using three #4 Philips Head screws (from step #3).
22. Install louvered top cover (supplied) using six #6 black Philips Head screws (from step 2).

This concludes the Rack Mount Retrofit Procedure.

9.5 Control Head Installations

The SG-2000 is a multiple control head radio. There are two ways to obtain a remote head configuration. First is to remove the control head supplied on the SG-2000. Second is to plug in additional control heads. While most people order their SG-2000 with the Remote Head Kit installed, this item may be installed in the field through the following procedure:

9.6 Remote Head Kit Installation (Part No. 04-12)

As supplied, the SG-2000 comes with a control panel attached to the front of the radio. As an option, a remote head kit, part number 04-12 may be installed, extending the control head 16 feet from the radio and supplying a gimbal mount. Installation takes 10 minutes.

TOOLS REQUIRED: Philips Head Screwdriver

TEST EQUIPMENT REQUIRED: None

CAUTIONS:

- **Power must be disconnected from radio for this procedure.**
- **Use care not to over tighten screws and strip threads.**

Installation Procedure

1. Locate and remove the wiring shield on the back of the SG-2000. This shield, which runs horizontally across the back of the radio, is held in place by three Phillips head screws. Unplug the control head number 1 cable.
2. Locate and remove the six black Phillips head screws which secure the top cover to the SG-2000 and remove the top cover. Two screws are located on each side of the radio and two screws are located on the top



- of the radio.
3. Turn radio upside down on a stable surface. Remove the six screws which hold the bottom cover of the SG-2000 and remove the bottom cover. Two screws are located on each side of the radio and two screws are located on the bottom of the radio.
Turn radio right side up.
 4. Locate and remove four Phillips head screws which hold the control head in place. (Two on each side.)
 5. Carefully slide the control head forward to remove it from the radio body.
 6. Remove control head cable from wire race in radio body. Remove external speaker jack feed. Note: External speaker jack only functions if a head is attached to SG-2000 body.
 7. Turn radio upside down. Reinstall bottom cover. Secure with six Phillips head screws.
 8. Turn radio right side up. Install top cover and secure with six Phillips head screws.
(Optional: Install Remote head in desired location and route cable to radio unit.)
 9. Plug remote control head into rear panel connector of SG-2000. Carefully install cable shield over the control wire and secure shield with three Phillips head screws. Cable clamp on left side of rear panel is not used with external control head.

Installation of the remote control head is now complete.

9.7 Additional Control Heads (Part No. 04-11)

Additional control heads may be added to the SG-2000 via the 10-pin connector located under the protective cover on the rear panel of the radio. In the event more than one additional control head is desired, a junction box is used. Please refer to the following diagram:

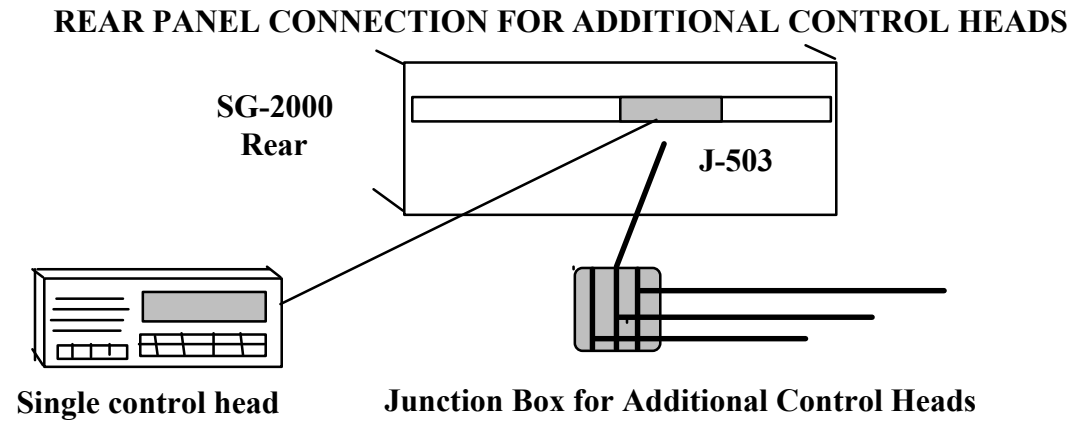



9.8 Remote Head Cable Extension

In the event that you need to extend the length of the control cable on the head of an SG-2000, two steps need to occur:

First, you have to remove the control head from the radio. The procedure above will allow you to remove the control head.

Second, you need to replace the existing cable with a longer one.

The cable which connects the SG-2000 to the control head(s) is attached to the units using standard connectors at each end. In this manner, the length of the control cable may be easily changed. Carefully unplug the existing cable assembly from the control head and radio and replace it with the desired length.

While we recommend that you use the control head wiring supplied by SGC, you may use any other 10-conductor shielded wiring. Remember, however, that the length of the cable run to a remote head is partly determined by the quality of wiring used. If you use very small conductors and try to exceed the 50 meter RS-422 standard distance, you may be disappointed. If, on the other hand, you choose suitably large conductors, (#18 or larger), you will achieve excellent results beyond 50 meters.

10.0 Power Supplies

Many power sources can be used with the SG-2000. Among these are:

- Transformer or regulated power supplies from AC mains
- Battery systems
- Solar Systems
- Wind Powered Systems

All modern transceivers run on 12 Volts DC. With the exception of AC mains power supplies, all other systems supply DC suitable to run a radio. However, various regulators may be necessary, because regulation of solar and wind powered systems is difficult.

Another important consideration, how power is moved from the power supply to the radio, can have a very high impact on ultimate radio performance, especially when transmitting.

10.1 Cabling

Regardless of the type of power supply used, you should design cabling from the power supply to the radio to minimize voltage drop. This drop occurs because wire is not a perfect conductor of electricity. The longer the distance between a power supply and a radio, the greater the voltage drop will be.

SGC recommends placing a power supply no more than 25 feet from a radio. There are two reasons for this:

First. The voltage drop experienced over 25 feet, even when large conductor cabling is used, is not acceptable.

Second. The longer the power cabling, the more chance that it will fail due to any number of unforeseen circumstances.

When electricity flows from the power supply to the radio at low current levels, the internal resistance of the wire has little effect. But as current increases, the voltage drop becomes more pronounced.

Now apply that to your power wiring: turn on the radio at a low power level, such as the receive mode where little power is drawn, and things will likely be just fine with number 16 or number 14 wire at 25 feet; but turn on the transmitter, where lots of

power is drawn, and nothing may work correctly because the voltage will drop dramatically.

Let's consider wire sizes between the power source and the radio. At 25 feet we recommend number 6 wire. At 12 feet we also recommend number 6. At 2 feet we recommend number 8, but we use number 6 because its more in line with our practice of building generous margins into all SGC products.

10.2 AC Power Supplies

There are two ways to convert high voltages AC from either 110 or 220 Volts to DC voltages suitable for operation of an HF radio, generally 12 Volts DC: conventional transformer-rectifier power supplies and switching type power supplies.

SGC does not recommend switching type power supplies for continuous commercial service for two reasons: First, unless the switching power supply is of exceptional design and properly installed, it will generate RF "hash" which will create a high local noise level. Second, switching type power supplies of inferior design are not as capable of continuous duty operation.

Some switching power supplies are quite good. Unfortunately, they are also very expensive and not as cost effective as a transformer-rectifier type power supply.

10.3 Transformer-Rectifier Supplies

Transformer-rectifier power supplies are by far the most reliable available. They are able to operate over a wide range of input voltages and offer resistance to failure under periodic overload conditions which would cause a switching type supply to fail.

Supply voltages for such power supplies are generally 110 and 220 volts AC with a frequency of either 50 or 60 Hz. Many aircraft also have 400 Hz AC available from their engine-driven alternators, but in these instances, it is usually better to power equipment from 24 volts (generally available on aircraft) than install a power supply to operate equipment from the 400 Hz AC power source.

High peak current is an important consideration if you are planning to operate in the voice mode. But if you are planning to operate in the data mode or will be using the transmitter on a more continuous basis, output capacity is less a factor than how heavily-built the transformer in the power supply is.

SGC does not generally recommend switching type power supplies in either a mobile or a base station installation for these two reasons: first, switching power supplies easily generate noise from the switching circuitry; second, under heavy loads, the switching type power supplies tend to stall and cause an interruption of power to your radio.

10.4 Mobile Power Supplies

In virtually all mobile power supplies, the source of power is the alternator or generator system of a vehicle and the battery. There are several principals of good design that come into play in the mobile environment which you should consider when going mobile on HF.

First, HF takes a lot of power on transmit. While you can use a single battery to power both the vehicle and the radio, SGC recommends the installation of an additional battery in all cases where this is practical. The reason for this is that the output voltage from a battery drops as the load increases. The more reserve current capacity, the lower the voltage drop under high intermittent power demands.

Some vehicles operate on 24 volt power in the mobile and marine services. There are two approaches which can be taken. First, you can put in a 24 volt to 12 volt converter. This is usually expensive. A much less expensive approach is to look for a 24 volt system which uses two 12 volt batteries in series. If you are fortunate to find this type of installation, simply use the 12 volt battery which has its negative post tied to ground and the positive lug at 12 volts above ground. Never use the battery on the other half!

In mobile operations, the biggest problem you will run into will be noise. While noise sources are easily found in fixed locations, in the mobile environment, including marine applications, noise sources may vary depending on engine speed and other variables.

Mobile power sources are notoriously noisy. Generators and alternators are only part of the problem which you will encounter. The presence of ignition sources including the coil, distributor and the spark plugs complicates matters. The best solution is to use a diesel engine and eliminate the ignition issue entirely.

When you are installing an HF system in a mobile setting, one of the best pieces of troubleshooting equipment you'll find is a small portable AM broadcast band transistor radio. With this radio, tuned to the highest end of its range (usually around 1600 KHz), you can use it as a hand-held noise probe to quickly identify sources of noise.

Good design practice dictates putting capacitors across the alternator or generator output and across the primary leads to the coil/distributor and at fans and other electrically operated devices. We've even found cases where power windows in a vehicle would cause RF "hash" on receive. The point is that you almost never have too many capacitors.

Ignition wire can be both a source of grief and a source of joy, depending on the vehicle. Most vehicles in North America come with resistor-type ignition wiring. This wiring has about 10 K ohms of resistance from the distributor to the spark plug. If you have a vehicle with solid ignition wiring and you experience RF "hash," a 10 K ohm, 10 watt

resistor in series with the ignition wire and installed at the distributor will usually help matters.

When you are tracking down ignition noise near a gasoline engine, you may find that the distributor is a major source of noise. Generally, you can't use capacitors to reduce noise from a distributor because the noise is coming from the spark generated for ignition. Adding enough capacitance to change the rise time of the spark voltage to a lower value which will reduce RF "hash" delays the time the spark will gap inside the engine. This means that timing will be changed (delayed) if a purely capacitive answer is sought.

Here, shielding of the distributor and wiring is likely to be the best answer. Even when you put shielding on the outside of ignition wires, you create a capacitor. Depending on the type of ignition system and the length of the spark plug wires, you may find timing retarded to the point that an engine will not deliver good performance without adjustment of timing.

10.5 Solar Powered Chargers

Not much needs to be said about solar charging systems except that good design practice needs to be followed to provide operation under all conditions which are expected to be encountered.

The most critical element in design of an HF solar power system is local weather conditions. If you are designing a solar system for an area where there will be little sunlight for many days in a row, then a large battery system will be needed along with additional solar panels. On the other hand, if you are designing for an area where there is a lot of sunshine at all times of the year, then you will need fewer panels; in some cases two 53-watt panels and one good gel cell battery will be sufficient.

Seasonality is also a consideration. Obviously, in the high Arctic, solar power is ideal for the month or two during the year when the sun never goes down. But in the other months, solar power is not a good idea. Hence, another consideration should be latitude where a solar system will be installed and a calculation of the number of hours of daylight which will be available.

The kind of regulator which is selected to control the output of the solar panel(s) is very important. It should operate over a wide range of loads and should continue to provide trickle charging to keep the battery system charged to its fullest between operating sessions.

11.0 Antenna Systems

The function of an antenna is to couple radio energy into space and the most important factor in considering an antenna is to realize an inescapable law of physics: big antennas are capable of doing a better job of coupling energy into space than are small antennas at any given frequency.

The single most important formula to know in dealing with antennas is that the size of a 1/2 wavelength dipole antenna is:

468 divided by the frequency in Megahertz.

$$(468/F \text{ MHz} = 1/2 \text{ Wave in feet})$$

The second most important fact to remember is that, due to space considerations, often-times the size of a MF or an HF antenna is a quarter wavelength.

This means for example that at 10 MHz (The frequency of the US National Bureau of Standards time and frequency standard stations WWV and WWVH) a half wavelength is 46.8 feet and a quarter wavelength is 23.4 feet. By the same token a broadcast station at 1 MHz (1000 KHz) has a quarter wavelength of 234 feet while a quarter wavelength at 100 MHz in the FM broadcast band is only 2.34 feet.

An antenna does not have to be a physical quarter wavelength in order to work efficiently: shortened antennas can be used. But any time an antenna is less than a physical quarter wavelength it will not have as much gain – or efficiency of coupling energy into space – as will a larger antenna. Use of a high performance antenna coupler, such as an SG-230 Smartuner™, Smartuner™ Pro, or SG-235, will improve performance of all antennas dramatically.

Short antennas represent some compromise. However, in many cases they can give good performance, especially in applications such as mobile HF work and in loops which are used where space is limited and noise levels are high. In other words, there are antennas which will provide performance better than a quarter wavelength antenna for a specific application.

Antenna length is not the only consideration. Another important factor is antenna wire size

11.1 Antenna Wire Size

Antennas are working their best when current in the antenna is high. A large wire will radiate more efficiently than a small wire.

Stranded wires will also radiate better than solid wires. Because AC electrical voltages are carried by the surface of a wire, stranded wire has more surface area and therefore radiates more efficiently.

If you wanted to design a good half wavelength antenna for HF work, you would select the largest wire possible because you know that at power levels of 150 watts and up, the difference between number 14 wire and number 6 wire can be as much as 3 dB. This means that just changing the wire size can double the effective radiated power coming from an antenna.

If you want to get the effect of a higher power transmitter, just increase the size of antenna wire. You can easily make a 150 watt radio perform like a 300 watt radio.

Another consideration with any antenna is the size and location of the counterpoise, the electrical "mirror" of an antenna. In the case of a center-fed dipole, it is the "cold" end of the dipole. On a vertical antenna, it is the ground system or the metal of a vehicle which is acting as a mirror. The counterpoise must be larger than the antenna or the system will not radiate effectively.

If you are ever working on an HF radio and you get RF "bites" when your hand touches the equipment or your lips touch a metallic microphone, you likely have a situation where the antenna is electrically "bigger" than the ground or counterpoise and so the counterpoise is radiating.

The height of an antenna over ground or counterpoise varies by the kind of antenna which is in use because this determines the take-off angle of the radiated signal. This is not an issue with vertical antennas as much as with horizontally mounted antennas.

In a vertical antenna the ground, or counterpoise, is parallel to the surface of the earth. Since the maximum radiation from vertical antennas is shaped something like a donut with a pencil through it with the pencil representing the antenna, you can see how the ground (which would slice the donut shaped RF pattern horizontally) would have little effect on take-off angle.

When you turn the antenna (yes, and that donut and pencil) over on its side to represent a horizontally mounted antenna, the donut becomes two half donuts lying on the surface of the earth. The take off angle – which is the amount of energy going toward the horizon – is lowered as the horizontal antenna moves up from ground level. The angle approaches its minimum one wavelength or more above ground.

There are also some other effects on antenna performance when it is raised up from ground. At low levels, down close to the ground, an antenna will exhibit a certain impedance (usually lower than at higher elevations). As a dipole antenna is moved up from the ground, it will go to a higher impedance until it settles at between 50 and 72 ohms at one wavelength over the ground.

Radio signals are polarized. This means that a signal coming from a vertical antenna will be best received by a vertical antenna, provided that the antennas are of equal gain. This means that even though a quarter wavelength vertical will likely be heard at distance better on a similar vertical than on a horizontal dipole antenna, a horizontal antenna array with substantial gain, such as a log periodic beam, will receive the signal better than either the vertical or horizontal dipole. Antenna gain is the best investment you can make because it works for you both in the transmit mode and in the receive mode.

A couple of other comments about polarization: most of the noises which you hear from over the horizon are vertically polarized so a horizontally polarized antenna will be quieter. And there are, in addition, circularly polarized antennas such as large delta loop antennas on low frequencies and quad type loops on the higher HF frequencies.

11.2 Near Vertical Incidence Skywave

Not all HF SSB work is done at transcontinental or intercontinental range. There is often a need to operate at close-in distances of less than 400 km. HF can provide a good solution for this type of communications. The technique is called Near Vertical Incident Skywave propagation (NVIS).

The NVIS antenna works on principles opposite those which lead to good long distance communications. Instead of sending maximum signal toward the horizon to hit the ionosphere at a shallow angle hundreds of miles away, the objective in NVIS antennas is to bounce almost straight up and come back down. While this antenna works great in the daytime and at short distances, it is very poor at night or when longer distances are being attempted.

NVIS antennas are generally low frequency antennas which operate from 2 to 7 MHz. The effect on performance of NVIS and groundwave radiation at these frequencies can only be established over a period of several days and several nights of operating.

11.3 Base Station and Fixed Antennas

With the discussion of some basic antenna principles in mind, you must decide what kind of antenna to install for a fixed station. If distances to be communicated are long, say over 1,000 Km, then a low angle of radiation is desired. The antennas which work best for these purposes are either vertical antennas, dipoles oriented so that their major lobe is in the desired direction (dipole lobes are perpendicular to the wire axis), or beam antennas.

At closer distances, inverted "L" wire antennas with a suitable high efficiency coupler such as an SG-230 work very well. Dipoles, folded dipoles, and any other efficient 50 ohm antenna will work well at distances up to 1,000 Km.

Loop antennas are best for receiving because they are quieted by presenting a short circuit to local noise pulses from industrial and commercial sources. But loop antennas need to be very large at low frequencies to radiate efficiently.

The basic design rule for all fixed antennas is "If you have real estate – use it." The bigger the antenna – within reason – the more effective the antenna will be. Also, except for NVIS applications, the higher the antenna, the better.

11.4 Antenna Feed Lines

You have to get power from the transmitter or transceiver to an antenna. To do this you need a transmission line. A lot of "old timers" in HF believe to this day that high impedance feedlines are best, but science doesn't agree with that point of view.

High impedance feedlines worked so well in the "old days" because tube type transmitters had a final amplifier impedance of between 5,000 and 10,000 ohms. Matching 5,000 ohms to a 500 ohm feedline meant a transformation of 10 to 1 – a simple task for a transformer – which is what the output section of a transmitter is.

Changing the match to 50 ohm lines meant the matching transformer had to match 100 to 1 – a more difficult chore with the opportunity for a lot more loss if everything wasn't properly adjusted.

With the advent of solid state radio equipment, the rules turned upside down. Now, a final transistor LPA (Linear Power Amplifier) impedance runs in the neighborhood of 1 to 2 ohms. This means that a 500 ohm line would be a 1- to -500 or 1- to -250 match – and not very good odds of getting things just right. The 50 ohm feedline represents a 1- to -25 or a 1- to -50 match – which is easily and safely designed.

Given this little bit of history, if you do not have the luxury of having a transmitter right at the antenna site – and this usually only happens in the case of AM broadcast band Medium Wave transmitters – then the best way to get RF from point "A" to point "B" is via 50 ohm impedance coaxial cable.

11.5 Antenna Couplers

If the transmitter and the feedline are both 50 ohms and the antenna is 100 ohms, a mismatch will occur. A portion of the power coming from the transmitter which should be radiated by the antenna will be "reflected" back toward the transmitter. As this occurs, standing waves develop on the feedline. The ratio of the peak voltage going to the antenna and the measured peak voltage reflected back to the transmitter by an unmatched condition is called Voltage Standing Wave Ratio (VSWR).

When a VSWR (SWR for short) exceeds about 2 to 1, the HF transmitter will reduce power to reduce stress on components. Reflected power has nowhere to go but to be turned into heat. This heat can be dissipated by the coax feedline or it can be dissipated by components in the output circuit of a transmitter. Either way, one of the rules of HF equipment is "heat is bad!" So it is in SWR considerations.

You can reduce SWR either by changing the length of the antenna or by introducing a matching network which will precisely match the conditions of the antenna to the requirements of the feedline: an antenna coupler.

If the SWR presented by an antenna is less than 2— to —1, the addition of an antenna coupler will make only a modest improvement in the transfer of energy. If the SWR exceeds 2 to 1, however, the results can be dramatic from this one piece of equipment.

One of the problems with earlier coupler designs was that the coupler was either a manual tuning device, such as a series of capacitors and roller inductors which had knobs and cranks on them, or the job was handled by large servo-motors which read voltages and made adjustments accordingly. But neither of these approaches was good enough for the new technology which has become available and which includes the next generation of adaptive HF radio controllers.

So SGC began to build computer controlled antenna couplers including the SG-230 and SG-235 Smartuner™ couplers. SGC began building the servo-motor type automatic couplers in 1975 so the transition to a computerized coupler with extremely fast retune times was a logical development. The SGC Smartuner™ is widely acknowledged as the finest antenna coupler available. We encourage you to use a Smartuner™ with the SG-2000 because few antennas will provide an even load over the wide range of frequencies covered by the SG-2000.

11.6 Mobile Antennas

The standard whip antenna used in the HF environment has a brief but interesting history related to the Citizen's Band radio craze which swept the United States in the 1970's. The "generic" 108 inch long stainless steel whip, while it could be mounted in such a way as to operate at 27 MHz without any coils, traps or matching network, it is



not generally well built and may fail when used in commercial service because of its poor base insulation and its lack of a shock absorbing base. It just whips around and doesn't stay where it belongs.

Single element commercial heavy duty antennas such as those made by Hustler are a step in the right direction for lower frequency HF work. Although some companies still sell 108" stainless steel whip-based products, the professional HF person will always choose a center or top loaded whip antenna if a single frequency is to be used.

When a series of frequencies spread across the spectrum is to be used, the professional answer is either to put up with changing loading coils or to put in a continuously loaded helically-wound antenna. This provides a reasonable load to a good antenna coupler at all frequencies from about 1.8 to 30 MHz.

SGC is the only manufacturer to add the good attributes of a 108" whip (which performs well at the 20 MHz range and above) with the high performance of a helical antenna that performs well at the lower frequencies.

The use of an antenna coupler is required on all but the most carefully matched center- and top-loaded mobile whip antennas which present close to a 50 ohm match to the antenna lead.

Although it is tempting to use both a coupler and a center loaded antenna, the center loading element of a loaded antenna already acts as an RF choke at high frequencies. Thus, it actually reduces the effective length of an antenna if used on a high band.

11.7 QMS Recommended for Mobile Use

SGC engineers have discovered that the QMS-II antenna system, comprising an SGC coupler (the SG-230 Smartuner™ or the two new couplers – the SG-230 Smartuner™ Pro and the SG-235) mounted in a QMS and driving the SG-303 high performance whip antenna will typically yield substantial improvement in gain over a conventional 1.8 to 30 MHz HF mobile antenna installation. When we start making claims of 20 dB, a lot of people (maybe even you) will be skeptical. So let us show you how you can get a significant increase in gain by simply using a QMS compared with any other 1.8 to 30 MHz system:

1. Most antennas are so heavy that they are mounted on the bumper of a vehicle. Because of this location, about a third of the antenna *is less than a foot from the grounded bodysheet metal*. This is equivalent to a capacitor of 25 to 100 pico Farads shorting your antenna. QMS, mounted high on the side of the vehicle, gains 3 to 6 dB.
2. Body sheet metal prevents the antenna from radiating evenly. It shields the signal in certain directions and causes *distorted radiation lobes*. QMS gains another 3 to 6 dB.

3. If an antenna coupler is mounted in the trunk of a vehicle, it will have 1 to 2 feet of HV cable going to the antenna on the outside. With as short as a 1-foot lead wire, and using a 9-foot antenna, this means that fully *10% of the antenna system is inside the vehicle* where it won't transmit or receive. It also creates another 10 to 100 pico Farads of capacitance which results in more losses! With QMS, you'll pick up 3-6 dB.
4. Wire size of the antenna counts. Almost the resonant type antennas are wound with number 22 wire. The SG-303, the antenna used with the QMS, is wound with 3 millimeter wide tape wire strap – equivalent to AWG # 4 wire. With a 100-watt class transceiver, you'll develop 3 to 7 amps (or more) of RF on the antenna, and *7 amps through #22 wire represents major losses*. The QMS with the SG-303 antenna scores another 3-6 dB advantage.
5. The SG-303, is actually *two antennas in a single casing*. A single rod equivalent to the conventional stainless steel whip element resonates at about 22 MHz; plus a helically wound element resonates at about 10 MHz. This means that on lower frequencies, those under 20 MHz or so, the SG-303 will vastly outperform a conventional 9 foot whip. Chalk up several more dB for QMS.
6. Some hams use the so-called “antenna tuner” built into some radios and feed their antennas directly with coax. The problem is that with a non-resonant antenna, a very high SWR exists on the feedline between the radio and antenna even if you get a low SWR reading with a built in tuner. *Built-in tuners are nothing more than trimmers*. The QMS system puts a true coupler right at the antenna. When your feedline SWR is above 4 to 1 you have effectively put 29 pico Farads per foot capacitance to ground! That's at least 3 to 6 dB more gain for QMS!

GAIN ADVANTAGE USING QMS!

As you can see, our gain advantage of 20 dB for QMS is pretty conservative! Here's one more thing to remember: QMS *mounts without drilling any holes* in your vehicle. That's a major advantage at vehicle trade-in time. So, if you're planning to use HF while mobile, SGC's QMS system is the best solution you'll find. *Contact your SGC dealer or call SGC direct.*

11.8 Unconventional Mobile Antennas

In HF mobile work, there are as many antenna alternatives as there are experienced HF installers.

The "J" antenna is perhaps best described as a bar rail type affair insulated from the top of a van, truck, or other flat roofed vehicle.



Loop antennas are similar, except that they will go all the way around the top of a vehicle and will have one side grounded to the coupler ground while the other side will be connected to the "hot" antenna lead at the insulator.

A variation on the "J" antenna is something called a "shunt fed" antenna, like a towel bar; it is used by some of our clients on aircraft and on top of various vehicles which have special communications requirements.

Other antennas which may be used successfully on HF may be found in the SG-230 Smartuner manual. We highly recommend the use of one of our Smartuners™ for all HF installations where practical.

12.0 Operating the SG-2000

Now with licenses, power supply, and antenna out of the way, let's get to the SG-2000 and its features.

This portion of the manual is divided into three sections: syntax, front panel diagram, and key functions.

Key functions are loosely grouped into two categories, basic and advanced. Basic key functions do not require the use of the Shift/Function keys. Advanced operations do require the use of the Shift/Function keys and may involve several key strokes.

The SG-2000 is a very sophisticated piece of equipment which may be operated on either a very simple level or may be used in a very complex manner. Please take time to read this portion of the manual carefully as it will assure satisfactory operation of the equipment for many years to come.

12.1 Syntax

The major differences between the SG-2000 and many other radios on the market are Memory, Channel, Frequency and Memory Bank.

The SG-2000 has a massive memory: Information on 744 channels may be programmed and the major difference between the SG-2000 memory and other radios is that the SG-2000 uses a more complicated memory table. While most radios can assign frequencies and modes to any memory position, the SG-2000 architecture goes one step further by allowing assignment of a channel number to any memory.

This means that in a conventional SSB radio, memory number 55 may be programmed to be KMI on ITU channel 403, so that any time this channel was needed, you would have to remember that KMI 403 is Memory #55 on your conventional radio.

The SG-2000 resolves this problem by allowing up to four digits to be used to identify a memory position. Hence, the memory position associated with KMI on ITU channel 403 is stored as memory 403.

We can't overstate the significance of this point. It is one of the reasons that conventional ham radio equipment is not suited to serious offshore use. Suppose that the radio operator with the ham ticket falls overboard on a cruise. Now the persons left aboard, who may not be hams, have to figure out how to run the radio.

With a ham radio type memory, they would have to know where, among the typical 100 memories, were programmed the frequencies for KMI.



With an SG-2000, all you need to figure out is where the power switch is and know enough to hit the channel button until four dashes appear (- - - -), punch in 403 (the channel number desired) and press the channel button again to select the frequency.

From this point, the radio will do the rest. You should know that when an SG-2000 is turned on, the speaker volume automatically comes up to a usable level. And if you are using one of our Smartuners™, it handles the antenna adjustments automatically.

Throughout this manual, we will be using the following terms:

"Memory" refers to the SG-2000 memory – the electronic box full of information.

"Channel" refers to the pre-programmed international standard channels which are permanently etched into the SG-2000 at the factory along with our own 65-channel collection of ham band edges which are also included.

"User Memory" refers to the user definable positions which you should think of as channels 1 through 99.

"Scan Bank #" refers to one of up to six banks of up to 10 channels each which may be assigned at user discretion.

"Programmed Scan" refers to scanning of the contents of the various scan banks or operating in the band scanning mode.

"Channel Scan" refers to a sequential scan of channels.

"Frequency Scan" refers to scanning up or down from a certain frequency.

"Band Scan" refers to scanning a range of frequencies defined by a lower and upper limit. This may also be referred to as bracketed scanning defined by an upper frequency and lower frequency.

Again, "Channels" has two meanings:

- A channel is a memory reference number assigned to a particular frequency.
- It also may be the ITU channel designator number.

User memories have numbers 1 through 99.

One other important concept related to memory is that the SG-2000 handles assignment of information based on channel number. This means that when you wish to delete a channel, you must handle deletion from the channel display, not the frequency display.

One other question that comes up from mariners from time to time is why some manufacturers refer to HF channels as "6A," "4B," and so forth. The "A" stands for the first simplex channel within a particular marine radio band when counted from lowest to highest frequency. Channel 6A would be ITU channel number 650 on a simplex frequency of 6215.0 KHz. This is also the 6 MHz band Distress frequency. Similarly, channel 4B would be 4146.0 KHz, the second simplex frequency on the 4 MHz band better known as ITU channel 451.

Channels 1-99 displayed on the SG-2000 are user defined.

Channels 100-200 may be factory assigned.

Channel numbers over 200 refer to the official ITU channel number .

12.2 Front Panel

The front panel of the control head of the SG-2000 radio is shown in the picture below. The next section, Key Functions, refers to the keys on this picture.

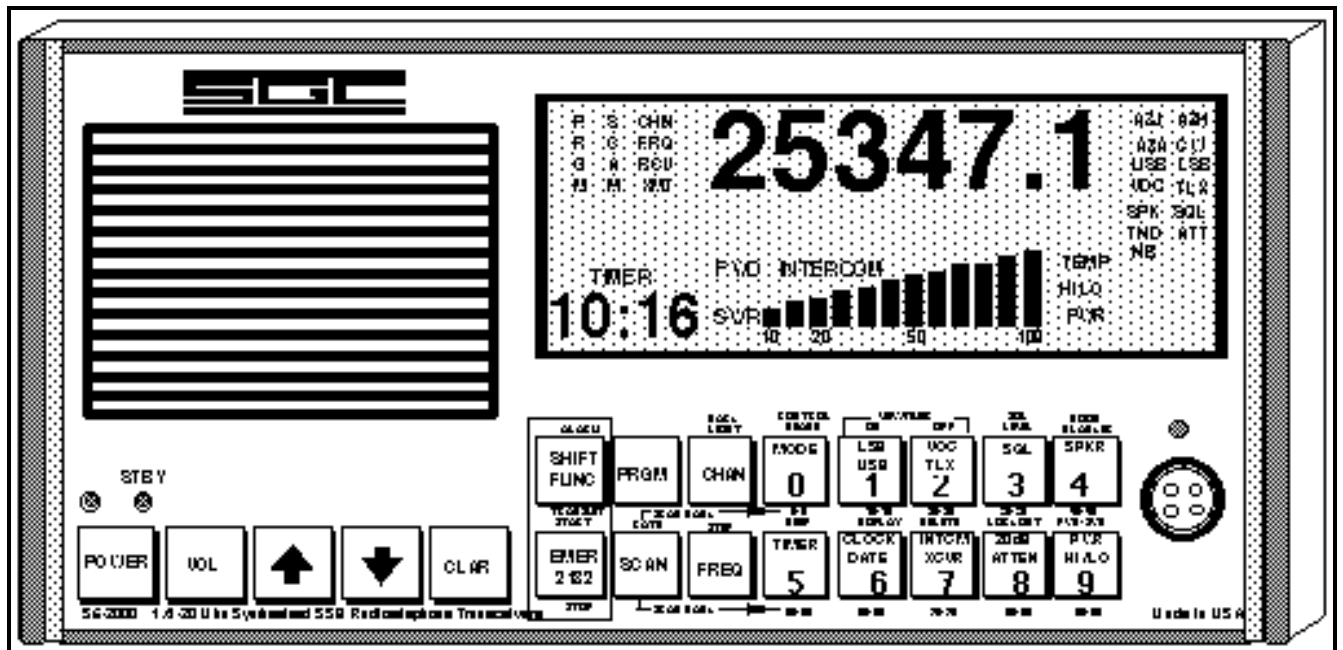

12.3 Push-Button Functions

BASIC FUNCTIONS

Power ON/OFF Press

NOTE: When you first turn on the SG-2000, it will automatically switch to the last frequency used.

Monitor 2182 KHz Press

Send Emergency ALARM Press +

WARNING: Do not test this function unless you are operating the SG-2000 into a properly shielded dummy load. Otherwise, authorities such as the U.S. Coast Guard may begin a search effort.

Increase Volume Press to increase or to decrease volume

Clarifier Press then or
NOTE: The Clarifier (receiver offset) has a range of +/- 600 Hz

Display Frequency Press

Display Channel Press

Change Channel Press until 4 dashes appear, enter channel number,

EXAMPLE: To call KMI on channel 401 press: , 401 ,

FREQUENCY FUNCTIONS

Enter a SIMPLEX Frequency Press , enter frequency,

NOTE: When a programming sequence begins with PRGM, you must press PRGM at the end of



the key sequence to execute the sequence.

EXAMPLE: To enter the simplex frequency 3920.5 KHz, you would

Press **PRGM** , **FREQ** 39205 **PRGM**

Enter a DUPLEX Frequency Press **PRGM** , **FREQ** *enter receive frequency* **FREQ**
enter mode **FREQ** *enter transmit frequency* **PRGM**

EXAMPLE: To enter the duplex frequency 3920.5 KHz receive, 3815.3 KHz transmit and Lower Sideband, you would press:

PRGM , **FREQ**
39205 **FREQ** **1** **FREQ** 38153 **PRGM**

NOTE: The 1 key toggles selection of LSB or USB in this example.

Increment Frequency Press **FREQ** then **Up Arrow** or **Down Arrow**

Change Frequency Step Press **SHIFT/FUNC** , **FREQ** then **Up Arrow** or **Down Arrow** to select step **SHIFT/FUNC**
[Note: Frequency step is shown on Liquid Crystal Display -LCD]

CHANNEL FUNCTIONS

Display Channel Press **CHAN**

Change Channel Press **CHAN** *until 4 dashes appear, enter channel number,* **CHAN**

EXAMPLE: To call KMI on channel 401 press **CHAN** ,
401, **CHAN**

MODE FUNCTIONS

USB/LSB Toggle Press **1** Observe front panel display changes

Voice - Telex Filter Switch Press **2** Observe front panel display changes

Squelch On / Off Press **3** Observe front panel display changes and



- receiver is silenced if no signal is present.
- Speaker On - Off** Press **[4]** Observe front panel display changes and speaker is silenced when SPK light is extinguished on LCD.
- Timer On - Off** Press **[5]** Observe "TIMER" indication over clock portion on LCD.
- Time - Date Display** Press **[6]** Displays clock time or date on front panel.
- Intercom On - Off** Press **[7]** *enter # of remote head desired* or **[7]** , **[0]** *for all heads*
- 20 dB Attenuator On - Off** Press **[8]** Observe front panel display changes
- Power High - Low** Press **[9]** Observe HI PWR or LO PWR flag on LCD.

SHIFT FUNCTIONS

- Back light Set** Press **[SHIFT/FUNC]** , **[CHAN]** then **[Up Arrow]** or **[Down Arrow]**
- Display control head ID** Press **[SHIFT/FUNC]** , **[0]**
- View Timer Frequency On** Press **[SHIFT/FUNC]** , **[1]**
- Alarm Time - Frequency Off** Press **[SHIFT/FUNC]** , **[2]**
- Squelch Level Set** Press **[SHIFT/FUNC]** , **[3]** then **[Up Arrow]** or **[Down Arrow]**
- Noise Blanker On - Off** Press **[SHIFT/FUNC]** , **[4]**
- Beep each key stroke** Press **[SHIFT/FUNC]** , **[5]**
- Alternate Time - Date** Press **[SHIFT/FUNC]** , **[6]**
- SWR Forward - Reverse** Press **[SHIFT/FUNC]** , **[9]**

SCAN FUNCTIONS



- Scan by FREQUENCY** RADIO MUST BE IN **FREQUENCY** DISPLAY MODE. PRESS **FREQ** BEFORE ACCESSING THIS FUNCTION. THEN:
Press **SCAN** then **Up Arrow** or **Down Arrow**
- Change Scan Direction** While Scanning, press **Up Arrow** or **Down Arrow**
- Change Frequency Step** While scanning by frequency, Press **SHIFT/FUNC** , **FREQ** then **Up Arrow** or **Down Arrow** Steps of .1, .5, 1, 3, 5 KHz may be selected.

CHANNEL SCAN

- Scan by CHANNEL** Press **SCAN** , **CHAN** (if dashes displayed, press **CHAN** again) , then **Up Arrow** or **Down Arrow**
- Scan Rate While Scanning** Press **SHIFT/FUNC** , **SCAN** , **Up Arrow** or **Down Arrow**
(8 bars =Fastest, 1 bar = Slowest)
- Scan by Scan Bank(s)** Press **SCAN** (if freq. displayed, press **CHAN** again) , enter bank #(s), then **SCAN**
- Define Scan Bank** Press **PRGM** , **SCAN** enter bank # (0-9), enter channel # in bank, OPTIONAL - press Up or Down for next scan bank memory], **PRGM**
- Delete Scan Bank** Press **PRGM** , **SCAN** enter bank # **Up Arrow** , **SHIFT/FUNC** **7**

DEFINE MEMORY

- Define User Channel Simplex** Press **PRGM** , **CHAN** enter channel #, **FREQ** enter RCV frequency, **FREQ** set parameters, **PRGM** . (RCV means "Receive")
- Define User Channel Duplex** Press **PRGM** , **CHAN** enter channel #, **FREQ** enter RCV frequency, **FREQ** set parameters, **FREQ** enter TX frequency, **PRGM**



Delete User Channel Press **PRGM** , **CHAN** enter channel # to delete, **CHAN**
(Begin with Channel Display) **SHIFT/FUNC** , **7** , **PRGM**

TIMER FUNCTIONS

Set Time ON Press **PRGM** , **5** on time **Down Arrow** , off time **PRGM**

Set Timer On Frequency Press **PRGM** , **5** , **FREQ** receive frequency **FREQ** mode
PRGM

Set Timer on CHAN Press **PRGM** , **5** , **CHAN** enter CHAN number **PRGM**

12.4 Sample Entries

Marine Use:

*It's easy to call the
Marine Operator!*

Here's all you need to do to call the AT&T Marine Operator on ITU Channel 401:

POWER To turn on the radio
CHAN Until 4 dashes appear.
4 **0** **3** Channel number desired
CHAN To execute channel change.

Ham Radio Use:

*Move to any Frequency
in 100 Hz steps!*

Here's all you need to do to get on to 14,290.0 in the 20 Meter Ham Band and tune down the band from this frequency:

POWER To turn on the radio
PRGM , **FREQ** Six dashes will appear
1 **4** **2** **9** **0** **0** Frequency desired
PRGM To execute frequency change.

Then, to QSY down the band (move frequency down) simply touch:

FREQ , **Down Arrow**

If you hold the down arrow, you will keep moving down the band. You can change the size of the frequency step easily. See **Frequency Functions**.



13.0 Tour of the SG-2000

The heart of the SG-2000 is the front panel. We have made that as uncluttered as possible while still being able to handle many advanced functions. The front panel of the SG-2000 is dominated by a large liquid crystal display (LCD) which dominates the front panel. The large display was selected because in many applications, the operating conditions of the radio need to be quickly determined. The large backlit display is easily read under all conditions. The backlight may be turned on and off or adjusted as conditions indicate. Now, let's explore the display and what the various LCD indicators mean.

13.1 Front Panel LED Display

REFER TO DRAWING - PAGE 43 (Left to Right - Top half of display)

PRGM Upper left corner of display. This indicates when the radio is in the Program mode. This mode is used to make permanent or temporary changes to the memories of the SG-2000. Think of this button as the "Enter" key.

SCAN Upper left corner of display. This is activated when the radio is Scanning. Note that the SG-2000 has several ways to scan: by Channel, by Frequency, and by Band. These functions are fully explained in the section Advanced Operations, later in this manual.

CHAN
FREQ
RCV
XMT

Upper left corner of display. These are status indicator lights which tell you what the SG-2000 is doing at any particular moment. Most times, you will have two of the four status indicators on. If you are listening to KMI on Channel 403, you would have the CHAN indicator on and the RCV indicator on. This tells you that the number on the display, to the right of the indicator is showing a channel number, in this case, 403. It also says that the radio is in the receive mode, as indicated by the RCV indicator.



LCD Numerals

Upper center of display. This shows the frequency or the channel which is being used by the SG-2000. Just left of the numerals is a flag which indicated "CHN" if channel information is displayed or "FRQ" if frequency is being displayed.

- A3J A3H**
- A3A CW**
- USB LSB**
- VOC TLX**
- SPK SQL**
- TND ATT**
- NB**

Upper right corner of radio. These indicators show the current mode of transmitting/receiving (A3J, A3H, A3A, CW), whether upper or lower sideband is selected (USB LSB), status of the voice/telex filter (VOC, TLX), whether speaker and squelch are activated (SPK, SQL), whether the antenna coupler is reporting tuned system (TND), if the 20 dB receive attenuator is active (ATT) and if the optional noise blanker (NB) is active.

REFER TO DRAWING - PAGE 43 (Left to Right - Bottom Half of Display)

Timer

Lower left corner of display. Indicates on or off status of radio timer.

Small Numerals

Lower left corner of display. Displays either the date or the time from the SG-2000 system clock.

FWD

S or SWR

Lower left center of display. In receive, the letter S is displayed and the bar graph to the right of the S will indicate relative signal strength. In transmit, either FWD or SWR will be displayed. Forward power is transmitter power going to the antenna. Alternatively, in transmit, SWR may be displayed. See section 11.5 of this manual for a description of SWR. (A good automatic antenna coupler, such as the SG-230 or SG-235 Smartuner™, will virtually eliminate SWR on antenna feed lines and increase transmitter efficiency.)

INTCM Lower center of display over bar graph. It indicates the intercom feature to another control head is active. (You can activate this feature on an SG-2000 with no additional heads attached, but no one will hear you!)

Bar Graph Lower center of display. Small numbers show under graph (10, 20, 50, 100). The bar graph displays relative strength of received signals and relative strength of transmitted signals.

TEMP Lower right corner of display. This light indicates a temperature condition which is abnormal for the transmitter and means that transmitter power output is being reduced to correct the condition.

HI LO

PWR Lower left corner of display. This indicates whether the transmitter is in the high or low power mode. High power output is 150 watts PEP on SSB and 150 watts CW while low power is 50 watts PEP and CW output.

Red LED's These two red lights are located in the lower left corner of the SG-2000 control panel just above the power switch.

The right hand light of this pair indicates that 12 VDC power is being applied to the radio and that the crystal oven, used for the onboard frequency standard, is available and is being supplied.

The left hand light above the power switch indicates that the radio's electronics are on and ready for operation. Please always allow for 10 minutes of warm-up for the crystal oven to insure the frequency standard has stabilized. This is especially important when the SG-2000 is being operated in extremely cold environments. The radio will, of course, work when first turned on with no warm up, but may be slightly off frequency in violation of regulations which govern operations.

13.2 Front Panel Controls

Control of the SG-2000 is accomplished through push buttons located on the front panel of the radio. We will cover the functions of each button; then we will do some actual "on-the-air" operations in the *Operating Session* section.

The primary functions of each button are imprinted on the button itself. The yellow 1 button is the number 1 when you are entering a frequency. When you are listening to the radio, it will toggle between LSB and USB (see Section 13.3 below). Shift functions are printed on the front panel above and below the button. These advanced functions are accessed by use of the Shift/Function key.

The key pad of the SG-2000 may be operated with or without a confirming beep when each key is pressed.

13.3 Primary Keyboard Functions

In this section, we will discuss the various primary keyboard functions beginning with the top row of buttons and working left to right.

SHIFT/ FUNC Pressing this key accesses the alternate key functions which are screened on the front panel of the SG-2000.

PRGM Pressing this key activates the programming mode, which tells the SG-2000 what to do. The best way to think of the Program function is to remember that commands must be "sandwiched between Program commands." For example, to program a simplex frequency directly into use, the keyboard sequence is PRGM, FREQ, enter the digits of the desired frequency and press PRGM to finish the programming operation. You will note that FREQ and the actual digits of the frequency desired were sandwiched between the PRGM key strokes.

It is best to think of the Program button as meaning both "Program" and "Enter."

CHAN If the frequency desired is currently displayed, the CHAN button will change the display to the corresponding channel number if the frequency has been assigned to one of the channel memories. If the desired frequency is displayed, but does not have a corresponding channel, the CHAN button enables the user to input a preprogrammed channel of their choosing .

The SG-2000 comes preprogrammed with all standard marine ITU and most SITOR channels (see ITU programmed frequency chart). The SG-2000 has the capability to hold up to 100 operator chosen channels in permanent memory.

MODE

Display of the current mode is in the upper right corner of the LCD display. The mode operation button allows the user to sequence through 4 modes of operations. The modes of operations are:

- 1) A3H: AM/AM compatible. On receive, this is the AM mode and utilizes the SG-2000's true AM detector. In transmit, the SG-2000 transmits compatible AM (sometimes called AME, meaning AM equivalent) which is single sideband with 40-50 W of the carrier re-inserted.
- 2) A3J: Single Sideband. This is the most commonly used method of voice transmission and is very efficient because all the transmitter power is devoted to carrying voice information. No power is wasted by transmitting a carrier.
- 3) A3A: Single Sideband with pilot carrier. This mode has a 4% pilot carrier reinsertion. This is commonly used among public shore stations and ITU stations where the carrier can be locked on and used by automated services.
- 4) CW mode: This mode is used for key coded transmissions. While in this mode the user can only transmit a 1 KHz tone by either keying the microphone or Morse code key.

These modes are sequenced counter clock-wise on the LCD display and are stored with the current configuration when the unit is turned off. Mode information may be stored as desired in the channel memory which also stores transmit and receive frequencies.

LSB - USB

The use of this button directs the transceiver to operate either upper sideband (USB) or lower sideband (LSB). U.S. and International Marine and Commercial regulations require that only upper sideband be used in marine frequency operation. Lower sideband may be used for Government or special applications only. In the amateur bands, frequencies on 40 meters (the 7 MHz band) and lower have traditionally employed lower sideband.

VOC - TLX

The standard SG-2000 has two selectable audio filters which allow the user to optimize the reception of incoming voice or data signals. The Voice filter, (VOC) allows a wide band width of 400 Hz to 2400 Hz. The second, the Telex (TLX) filter, is a tight filter centered at 1700 Hz. This filter increases the "signal to noise ratio" of the frequencies used in SITOR, RTTY, and FEC communications by removing unwanted noise.

Technical note for advanced users: SG-2000's which have been ordered for ALE (Automatic Link Establishment), or adaptive HF controller service employing Digital Signal Processing (DSP) systems are specially modified to use the VOC-TLX switch to turn the automatic (receiver) gain circuits (AGC) on and off. This configuration is selected by moving a jumper on the exciter board of the radio. ALE and other advanced government protocols require that automatic gain control circuits be defeated. This modification allows the AGC speed switch to be called via the serial port. The modification removes the TLX filter function which is not used under wide spectrum digital protocols. The PRC-2250 MIL is supplied standard with the ALE modification selected by the internal jumper.

SQL

The squelch is used to block non-voice reception (e.g. atmospheric background noise) and is incorporated in most SSB transceivers. The SG-2000 converts the signal to a digital form. The signal is then analyzed by the micro-processor to determine if it is a voice signal. If the signal is determined to be voice, it is allowed to pass. If not, the radio remains silent. This feature provides a faster response time to the incoming signal so that no data is lost.

SPK

This button will engage the front panel speaker on or off. This feature is utilized when the privacy of using a telephone style handset is desired. The SG-2000 back panel speaker jack (J-505) is also controlled by this switch. Please note that when the SG-2000 is first turned on, all control heads are nor-malized at one half volume, regardless of the last setting of the SPK switch.

Note: External Speaker jack J-505 is only usable when the SG-2000 is used in the control head attached to the radio configuration.

20 DB ATTN

This control inserts or removes a special -20 dB receiver gain reduction pad in the front end receiver of the SG-2000. When this pad is in the ON position, the SG-2000 reduces it's sensitivity to overcome unwanted RF noise, interference signals

and helps to prevent signal overload when communicating with nearby stations. Signal overload occurs only when your location is extremely close to another transmitting station or the amount of signal arriving at your location is extremely high due to high power transmitters and high gain directional antennas being used.

If your SG-2000 is operated in the area of high power broadcast stations, you will appreciate that the SG-2000 comes with a Broadcast Band filter. This filter will virtually eliminate all AM broadcast signals allowing the SG-2000 to operate in the same room with very high power AM broadcast transmitters.

PWR HI/LO

Power to the transmitter is controlled by this button. When power is reduced, or on LO, the maximum output power is approximately 35% of the full power available. This feature can be used when your normal power output is overloading (saturating) the receiver of the station with whom you are communicating. In the LO power mode, the SG-2000 consumes less DC current and will therefore reduce power consumption from the supply battery. This feature is recommended to save the life of the battery and is useful when using the SG-2000 under sail or when solar and other power sources are low.

INTCM/XCV

The SG-2000's intercom system is unique, allowing communication between the user and any or all of up to eight separate control heads. By engaging this button and "0", the user may communicate with all control heads by using the microphone. Engaging this button then pressing the number of another control head (1 - 8) enables the user to privately communicate with a specific control head. The control head ID numbers are programmed at the factory and the control head number, which is permanently etched into the memory of the control head MicroProcessor can be displayed by pressing the "SHIFT/FUNC" and then the number 0 on the keypad. The LCD will display the head number in the frequency window.

CLOCK/DATE

The lower left hand corner of the display shows the current time or date. Either option may be selected by engaging this button. The default setting preferred by most users is the clock function. Time is displayed in military (24 hour) format. If you are making position sightings, you may wish to check the clock periodically against the U.S. Bureau of Standards time stations, WWV and WWVH. These may be found 24 hours a



day on 2.5, 5, 10, 15, and 20 MHz providing time of day, storm warnings and navigation aid updates including the status of GPS satellites.

TIMER

This button engages/disables the alarm time programmed into the unit. (See Function Operation Instructions). When engaged, the unit will automatically shut down at midnight if there is no previous pre-programmed time. The SG-2000 may be programmed to turn on, tune to a pre-assigned frequency and mode of operation to receive daily broadcasts. At the end of these broadcasts, the radio can then be programmed to turn itself off.

This feature is used to schedule receiving weather faxes in unattended operation. It may also turn on the radio for a regularly scheduled net or if you want to use the SG-2000 as a sophisticated clock radio.

FREQ

This function displays the frequency being received or transmitted. If the Channel is currently displayed, pressing the Frequency key will switch the display to the receive frequency of the channel. If the frequency is being displayed, pressing this key, then the up or down arrows will change the operating frequency of the radio.

If an arrow button is depressed and held down, the SG-2000 will begin tuning in discrete steps (as small as 100 Hz or as large as 5 KHz) until the button is released or the end of its frequency range is reached. The size of the frequency steps is adjustable. See the Shift/Function section for details of changing frequency steps using the SHIFT/FUNC + FREQ command.

SCAN

The Scan button engages the automatic scanning functions of the SG-2000. The scanning function operates in three different modes; scanning by frequency, scanning by channel, and scanning by scan bank. Scanning may also be controlled by an external device such as a computer or ALE controller. When operated by an ALE controller the SG-2000 will scan at speeds in excess of 5 channels per second. Manual operation is variable from 5 seconds per channel to approximately 5 channels per second.

In the frequency mode, the SG-2000 will scan up or down in discrete steps defined by the Step Function. By pressing either the up or down arrow, the direction of the scan can be changed to direct the scan to the desired frequency range. If the squelch is activated in scan, the unit will continue scanning until activity breaks the squelch. The unit will then pause for 5

seconds and if there are no more breaks in the squelch, the unit will continue in the original direction.

The scan channel mode is similar to the frequency mode in that when activated, the unit will begin to scan factory programmed ITU-VOICE and ITU-SITOR channels. The direction of the scan can be changed using the up and down arrows. When pressing the arrows in scan, the unit will step once in that direction and then pause for approximately 2 seconds. This will allow the manual stepping through of the scan routine to find activity. The ITU or SITOR channels can be selected by first setting the radio in VOC or TELEX modes respectively.

The programmed scan mode allows you to program channels into one of six banks or files for scanning. There are six banks with up to 10 files in each, allowing up to 60 channels to be programmed. When scanning, the unit will search through the selected banks at a pre-determined rate.

This scan rate may be changed at any time using the *SHIFT/FUNC* + *RATE*. keys. If the squelch is on during the scan routing, scanning will pause on a squelch break. If there is no further activity on that channel, scanning will resume after 5 seconds. The up/down arrows can be used to change the direction of the scan and to step through the scan banks manually.

13.4 Shift Functions

To access the secondary function keys on the upper half on the front panel, the operator will depress the *SHIFT/FUNC* key prior to pressing the desired key. Secondary functions of keys (The functions printed above the buttons on the panel) are described as follows:

Back Light This function engages the back lighting of the front panel. To change the back lighting, press "SHIFT FUNCTION," "CHANNEL," then use the up or down arrow to adjust the back lighting to a comfortable level.

Control Head # This key is used to view the Control Head number pre-programmed by the manufacturer (see INTCM-XCV key in preceding section).

View Timer These two keys are used to preview the pre-programmed alarm times and their corresponding channel or frequency.

SQL Level This function allows you to set a squelch level by using the Up

or Down arrows. To optimize the squelch level, depress the Up and Down buttons respectively and increase the SQL-Level once or twice. This function allows for optimum detection and minimum background noise. For viewing purposes, the adjustment levels are displayed on the bar coded meter.

Noise Blanker

This optional feature allows the radio to recover information that would otherwise be drowned out by high powered impulse type noise. In noisy environments, engine spark noise, lightning, radar pulses or other EMI sources can cause the radio's built-in automatic gain control to reduce the sensitivity to the input signal. With the noise blanker, incoming noise is detected and turns off the receiver for the length of the noise pulse, thus preventing the automatic gain control from causing desensing.

FWD - SWR

This function is used to display the output power and returned (lost) power when transmitting via the bar graph portion of the display. Widely fluctuating readings of either the FWD or SWR when in the CW transmit mode usually indicate problems such as an improperly tuned antenna or a faulty connection between the radio and antenna. Situations such as these can harm the radio and should be resolved immediately.

Lockout

Function not available in this version of SG-2000. (Applies to custom need. Not to be confused with scanning lockout as described on page 73).

Delete

The SHIFT/FUNC plus DELETE sequence is used to delete obsolete or incorrect information when in the PRGM mode.

Display

Engaging this key directs the date and time to flash intermittently on the display in 2 second intervals, thus allowing the operator hands-free access for viewing time and date.

Beep

This key is used to engage audible sound (a beep) when any key is depressed. To turn off the beeping sound, press the SHIFT/FUNC plus BEEP keys again.

Step

The Step function is used in conjunction with the frequency function to allow the operator to select the size of frequency step. The steps are in preprogrammed increments of .1 (100 Hz), .5 (500 Hz), 1, 3 and 5 KHz. If you are operating in ham bands (and especially when using CW), the 100 Hz (.1 KHz)

mode is best. On the short wave broadcast bands, scanning at 5 KHz is great!

Rate The Rate function allows you to select pre-programmed scanning speeds of both frequencies and channels which range from .2 seconds to 40 seconds. See Section 13.11, Changing Frequency or Channel Scan Rates, for specific rates.

13.5 Program Functions

As was mentioned earlier, remember that the PRGM key means two things. At the beginning of a key sequence, it means "OK, do the following." At the end of a key sequence, it means "OK, enter the preceding and execute the command."

The Program Functions allow the operator to program the following:

Channel Up to 100 channels can be entered by the operator. These channels will remain a part of the pre-programming of the unit until deleted by the operator. All pertinent information such as USB/LSB mode, VOC/TLX, and Attenuator can be programmed by means of this function and mode.

Clock/Date The current time or date can be entered by means of this function.

Timer The Timer function allows the unit to power itself on or off at any time to a specific preprogrammed frequency or channel of your choice .

Frequency This function is used to select any frequency between 500 KHz thru 30 MHz (transmit has been disabled below 1.6 MHz.) Care should be taken not to transmit on restricted frequencies.

Scan This function is used to program the different banks used by the scanning function. The bank number is programmed first, then the desired channels to be contained in that bank. The up or down arrows are used to step through each bank.

Lock Feature The SG-2000 can be limited to channelized operation. This function is used to prevent transmission on any frequency chosen to be locked out. This is useful in areas where there are restricted frequencies in which to operate. (See *Transmit Channel Locking* on page 73 of this manual for the sequence to turn the feature on and off.)

13.6 Operating Session

This section will give you practical key entry sequences which will make operating the

SG-2000 very efficient.

Power

Before turning on the power to the SG-2000, you may notice a red stand-by light glowing on the lower left portion of the control head. This indicates the 12 VDC power is available for the radio.

- If you do not see the red stand-by light on, please check your 12 VDC power wiring to determine why power is not being supplied to the radio.
- The temperature of the onboard crystal oven can be maintained ready for power-up if the oven switch (on the rear panel of the SGC-2000) supplies 12 VDC power. The red stand-by light will remain on. (As you will recall from the introduction to the radio, the onboard frequency standard uses a highly stable crystal oscillator.)
- If the temperature of the onboard crystal oven has not been maintained, allow 12 VDC power to be applied for 10 minutes or longer. If you do not do this, the frequency will not be standard and off-frequency operation may be noticed. Failure to allow the oven to come up to temperature may result in operation on an improper frequency.

Power on. Once the availability of power has been confirmed, push power button to turn on radio.

The control head should start displaying radio status information.

The first frequency displayed will be the last frequency used prior to the radio being turned off.

You may also notice when power is turned on that the radio comes up at partial volume. The SG-2000 always comes on at its last volume setting before it was last turned off.

Display. Now, notice the frequency/channel portion of the display. The indicator to the left of the numbers will inform you whether CHN (channel number) or FRQ (frequency) is being displayed. If Channel is displayed, go to the CHANNEL section to continue operating in the channel mode. If you wish to operate in the frequency mode, go to FREQUENCY section.

If you are in CHN and wish to see FRQ, press the "FREQ" button. If you are in the FRQ mode and wish the display to show channel information, simply press "CHAN". If the

frequency displayed does not have an assigned channel number, four dashes will appear on the display. This indicates that the radio is not operating on a channel (and mode) which is in memory.

13.7 Channel

Change Channel - Voice Mode

In order to change the operating channel, press the CHAN key until four dashes appear. You will need to press it one or two times before the dashes appear.

With the dashes displayed, type in the desired channel number with the key pad. Then press the CHAN key a second time to enter the command.

(Refer to the Quick Reference Card)

If the channel desired is a four digit channel number, the function will be entered automatically following input of the fourth digit.

Change Channel - Telex Mode If the new operating channel desired involves the use of the Telex mode, you must change the mode to Telex *before* attempting to change to a SITOR channel.

This feature is incorporated into the SG-2000's software programming to prevent accidental entry and accidental voice use of SITOR channels. Voice on these channels could interfere with data reception.

As you can imagine, if this feature was not incorporated, it would be possible to enter channel 812, a SITOR channel, accidentally when you meant to enter channel 812, a semi-duplex ITU voice channel.

Use the following sequence to change to a Telex SITOR channel:

- 1) Set mode to TLX by pressing the "VOC/TLX" button. TLX will be displayed on the right hand side of the LCD display.
- 2) Depress "CHAN" button until dashes appear. Press "CHAN" once if CHN flag is on left of numbers, or twice if FRQ flag is on).
- 3) Enter the desired SITOR channel number.
- 4) Depress "CHAN" key to enter the channel and make it current.

13.8 Frequency

Frequency Change - General

There are two ways to change the operating frequency of an SG-2000. For large frequency changes, you may use the direct entry method. For small



changes of frequency you may use the UP/DOWN arrow. When these arrows are used, the frequency will increment in the desired direction (UP or DOWN) in steps of .1 (100 Hz), .5, 1, 3, and 5 KHz. The size of the step is set by the *Change Frequency Scan Step* procedure described on page 69.

Frequency Change - Direct Entry

To change to a new operating frequency via the direct entry method, the following steps are used:

- 1) Press "PRGM" to alert the memory that new information is coming.
- 2) Press "FREQ" to specify that frequency numbers will follow.

- 3) Enter the frequency digits including the first number to the right of the decimal point. If you are satisfied with the mode and are not working duplex (that is, a different receive and transmit frequencies), go to Step 4. Otherwise, continue here.

Optional: After you have keyed in the digits for the direct entry frequency you may change two other variables. You can specify mode and specify a transmit frequency if you wish it to be different from the receive frequency.

- 4) You may press the "FREQ" button again at this time to enter MODE information and select the desired sideband (USB or LSB).
- 5) You may press the "FREQ" button once more to bring up 6 dashes which are displayed as [- - - - -]. This is where you enter your desired transmitter frequency.

Note: While most of the ITU High Seas voice channels use relatively small frequency differences of under 1 MHz, the SG-2000 may be operated with any difference desired. For example, if you wanted to transmit on 2 MHz and listen on 26 MHz, this is easily within the capability of the SG-2000.

- 6) Press "PRGM" to enter the information into memory and execute the function.

Frequency Change - Incremental

To change frequency a relatively small distance, you may use the following sequence.

- 1) Press "FREQ" once if FRQ flag is on, twice if CHN flag is on.
- 2) Press the "Up" or "Down" arrows.

You will notice that the frequency displayed is changing by the increment specified by the *Change Frequency Scan Step* function.

Clarifier Use When you are on the desired channel or frequency, you may fine tune the receiver by using the Clarifier. This allows the receiver to tune ± 600 Hz from the current frequency and may be used to make a voice sound more natural. Alternatively, it may be used to adjust the tone of a CW station to a desired frequency.

The sequence to use the Clarifier is:

- 1) Press "CLAR."
- 2) Press the "Up" or "Down" arrows.

You will notice that if you tune lower while listening to a voice on lower sideband, the voice will become lower in pitch. If you turn lower while listening to a voice on upper sideband, the voice will become higher.

Fine Tuning - CW Operation

If you are using the SG-2000 in the CW mode, you should tune in the desired station by pressing the Frequency button and then change the frequency using the UP and DOWN arrows until the received station is heard at the same pitch as the CW sidetone emitted from the control head speaker when you key the radio.

When this is done, you will be operating on the same frequency as the station you wish to work.

If you then wish to adjust the note or tone of the CW station, this may be done with the clarifier. You will be able to adjust the note between 400 and 1600 Hz.

SPECIAL NOTE: Do NOT use the SG-2000 on CW in the LO PWR mode. If you desire to operate CW and LO PWR, use an external tone source and connect it to the external audio I/O port J-301 located on the rear panel of the SG-2000. Vary the amplitude of the external tone source to control output power of the SG-2000.

13.9 Programming

Program User Channel into Memory

User-defined channels are assigned channel numbers 1-99. You may designate any frequency to be a channel from 1 to 99. Channel 0 is displayed as E0 – the international distress frequency – and may not be reassigned.

Enter a Simplex Channel into Memory

The following steps are required to assign the *simplex* frequency 14,735.1 KHz to user channel 09:

- 1) Press the "PRGM" button.
- 2) Press the "CHAN" button.
- 3) Enter the desired channel number (09.)
- 4) Press the "FREQ" button.
- 5) Enter the desired frequency including one digit right of the decimal point. (147351.)

- 6) Press the "FREQ" button to select mode of operation.
- 7) Press the "PRGM" button for simplex operation and to end the programming sequence.

Enter a Duplex Channel into Memory

If the desired channel is a *duplex* channel (e.g. different receive and transmit frequencies), these additional steps are required:

- 1) Follow steps 1 through 6 as shown above under Entering Simplex Frequency into Memory.
- 2) After step #6, press the "FREQ" button once more. Six dashes will be displayed on the LCD [- - - - -].
- 3) Enter the transmit frequency
- 4) Press the "PRGM" button to enter the information into memory.

Deleting Errors in Entry

In the event an error is made entering information, press the "SHIFT/FUNC" button and the "7" button to delete any errors. Repeat this sequence as necessary.

Delete a Channel from Memory

You may not delete a frequency from an SG-2000. You may only delete user-definable channels. You may or may not be on the channel you wish to delete. To delete a channel, use the following key sequence:

"PRGM", "CHAN", "the channel number you wish to delete, if channel 1-9, you must add a preceding 0", "CHAN", "SHIFT", "7" and "PRGM".

13.10 Scanning Functions

The SG-2000 will scan both frequencies and channels. You can scan from 2 to 30 MHz continuously in 100 Hz steps. Or, you may scan just a few of the hundreds of channels.

Program a Channel Bank

The SG-2000 has six channel banks numbered 00 to 05. Each of these banks will hold up to 10 channels, complete with mode and offset (if duplex). The entry sequence is:

- 1) Press the "PRGM" button.
- 2) Press the "SCAN" button.

Note: The display will show the "PRGM" indicator active with the large digit display showing a "-0" on the far left.

- 3) Enter the desired bank number to be programmed (0-5). The display will show the bank number on the far left of the display and the previous channel programmed in the first file of that bank. If the file has not been previously programmed, the display will show four dashes to indicate it is empty.
- 4) If the file is empty, as indicated by four dashes, enter the desired channel number.
- 5) Press the "Up" arrow to proceed to next file in that bank and repeat step 4, or press the "PRGM" key to end the function.
- 6) If a file is not empty, the file can be deleted by first engaging "SHIFT/FUNC" and then "7" or "INTCM/XCV."
- 7) Press the "PRGM" button to end the function.

Scan by Frequency - General

- 1) Press the "SCAN" button.
- 2) Press the "FREQ" button.

Note: If there are no buttons pressed within 4 seconds, the unit will start scanning automatically from the original channel on display at the start of the function.

- 3) To change the direction of the scan or to step through the frequencies, press the respective "Up" or "Down" arrow.
- 4) To allow the pause on detection, press the squelch by pressing "3" or "SQL."
- 5) To stop the scan, simply press the "SCAN" button.

Scan by Frequency - Specific Range

This is an advanced function and should be studied closely. Also called Program or Band scanning, it allows the SG-2000 to scan in a particular mode between two frequencies. There are two steps to using band scanning with the SG-2000. First, you will need to load channels into the scan brackets. This tells the radio the range within which to scan. When you are done using the band scanning, you will need to unload the scan brackets to allow the radio to resume normal scanning operation.

Load Frequency Limits

Before following this sequence you will need to have the upper and lower frequencies assigned to memories. This is explained in an earlier section. For the purpose of this discussion, let's suppose that you have put 3900 KHz LSB into Channel 22 and 4000 KHz into Channel 23.

- 1) Press "PRGM."
- 2) Press "SCAN."
- 3) Press "CHAN." Display will flash [LC: - - - -] (lower channel).
- 4) Enter the channel number of the lower frequency. In this example, 22.
- 5) Press "CHAN." Display will flash [UC : - - - -] (upper channel).
- 6) Enter the channel number of the upper frequency. In this example, 23.
- 7) Press "PRGM" to exit programming and execute commands.

Begin Scanning

This is done by simply displaying frequency and scanning. If you start within the frequency range bracketed, the radio will simply go low to high or high to low, depending on whether you have pressed the "Up" or "Down" arrow.

If you begin scanning frequencies which are outside of the range, the radio will only scan to the range. (e.g. If you start scanning down from 28.400 MHz, the radio would scan down until it got to 3.9 MHz and would then scan only from 4.00 MHz to 3.900 MHz after it reached that range.)

Unload Frequency Limits

In order for the SG-2000 to resume normal frequency scanning (scanning up or down anywhere in its range), it is necessary to unload the scan brackets. To do this, the following sequence is used.

- 1) Press "PRGM."
- 2) Press "SCAN."
- 3) Press "CHAN."
- 4) Display will show [LC : - - 2 2] (If Channel 22 is lower limit.)
- 5) Press "SHIFT/FUNC."
- 6) Press "7" (the delete key in the SHIFT/FUNC mode.)
- 7) Press "CHAN."
- 8) Display will show [L C : - - 2 3] (If Channel 23 is upper limit.)
- 9) Press "SHIFT/FUNC."
- 10) Press "7" (the delete key in the SHIFT/FUNC mode.)
- 11) Press "PRGM" to execute the function and exit the programming mode.

Scan by Channels

- 1) Press "SCAN."
- 2) Press "CHAN." (If dashes appear, press CHAN again.)

Note: If there are no keys pressed within 4 seconds, the unit will start scanning automatically from the original channel on display at the start of the function.

- 3) To change the direction of the scan or to step through the channels, press the respective "Up" or "Down" arrow.
- 4) To allow the pause on detection, press the squelch by pressing "3" or "SQL."
- 5) To change from scanning the ITU channels to the SITOR channels or visa versa, set the unit in VOC or TLX mode respectively by engaging the "2" or "VOC/TLX" button.
- 6) To stop the scan, simply press the "SCAN" button.



Scan by Channel Banks

- 1) Press the "SCAN" button.
- 2) If the frequency is displayed, press the "CHAN" button to display six dashes.
- 3) If six dashes are already displayed, type in the desired banks to scan. Example: By entering "0134" the radio will scan through banks 0, 1, 3, and 4. If an empty bank is selected, the unit will first try to scan through that bank; however the bank will be eliminated once it is determined the bank is vacant.

Note: If there are no keys pressed within four seconds, the unit will begin scanning automatically from the original channel on display at the start of the function.'

- 4) Press the "SCAN" button again to begin scanning.
- 5) To change the direction of the scan , or to step through the scan banks, press the "Up" or "Down" arrow.
- 6) To allow the pause on detection, press the squelch by pressing "3" or "SQL."
- 7) To stop the scan, simply press the "SCAN" button.

13.11 Changing Frequency or Channel Scan Rates

Separate scan rates are available for frequency or channel scanning. You must be in the frequency scan mode to set frequency scan rate and in channel scan to set channel scan rate. If the unit is not scanning, the function will change the rate of the last scan mode performed.

Change Frequency Scan Rate (In Frequency Scan Mode)

- 1) Press the "SHIFT/FUNC" button.
- 2) Press the "SCAN" button.
- 3) Press the "Up" or "Down" arrow to change the rate to the following:
 - a) 1 step per second |
 - b) 2 steps per second ||
 - c) 5 steps per second |||
- 4) This function will automatically time out after four seconds.



Change Channel Scan Rate (In Channel Scan Mode)

- 1) Press the "SHIFT/FUNC" button.
- 2) Press the "SCAN" button.
- 3) Press the "Up" or "Down" arrow to change the rate to the following:
 - a) 1 channel per 40 seconds |
 - b) 1 channel per 20 seconds ||
 - c) 1 channel per 10 seconds |||
 - d) 1 channel per 5 seconds ||||
 - e) 1 channel per 2 seconds | ||||
 - f) 1 channel per second || ||||
 - g) 2 channels per second ||| ||||
 - h) 5 channels per second |||| ||||
- 4) This function will automatically time out after four seconds.

Change Frequency Scan Step

- 1) Press the "SHIFT/FUNC" button
- 2) Press the "FREQ" button
- 3) Press the "Up" or "Down" arrow to change the rate to the following:
 - a) 100 Hz per step
 - b) 500 Hz per step
 - b) 1000 Hz per step
 - c) 3000 Hz per step
 - d) 5000 Hz per step
- 4) The function will automatically time out after four seconds.

13.12 Additional Functions

Timer

To turn timer on and off:

- 1) Press "5" or "TIMER"



Display Alarm Time ON and Frequency

- 1) Press the "SHIFT/FUNC" button.
- 2) Press "1" or "LSB/USB" button.

Display Alarm Time OFF

- 1) Press the "SHIFT/FUNC" button.
- 2) Press "2" or "VOC/TLX."

Program Time ON-OFF

- 1) Press the "PRGM" button.
- 2) Press "5" or "TIMER."
- 3) Type in 1-4 digits for time on in 24 hour format
- 4) Press down arrow to program off time or "PRGM" to end

Program Time ON Frequency

- 1) Press the "PRGM" button.
- 2) Press the "5" or "TIMER" button.
- 3) Press the "FREQ" button.
- 4) Type in frequency desired
- 5) Press the "FREQ" key for more parameters or "PRGM" to end.
- 6) Press desired parameters (*LSB, ATTN, VOC, ...ETC.*)
- 7) Press the "FREQ" key for transmit frequency or "PRGM" to end.
- 8) Type in transmit frequency desired.
- 9) Press the "PRGM" key to end or the "FREQ" key to repeat settings.

Program Timer on Channel

- 1) Press "PRGM."
- 2) Press "5" or "TIMER."
- 3) Press "CHAN."
- 4) Type in desired channel number
- 5) Press "PRGM."

Clock / Date

To toggle between time of day (24 hour format), and date:



- 1) Press "CLOCK/DATE."

Set Clock

- 1) While clock is displayed, press the "PRGM" button.
- 2) Press "6" or "CLOCK/DATE."
- 3) Type six digits for time desired (*ie..131500 FOR 1:15 PM.*)
- 4) Press the "PRGM" button to end.

Set Date

To program in the date:

- 1) While date is displayed, press the "PRGM" button.
- 2) Press "6" or "CLOCK/DATE."
- 3) Type six digits for date desired in the format MM DD YY.
- 4) Press the "PRGM" button.

Attenuator

To turn 20 dB Attenuator on or off:

Press the "20 dB /ATTN" button.

Power HI-LO

To change output power level:

Press the "PWR/HI LO" button.

Volume

To change the volume level:

- 1) Except in Scan, volume can be changed by pressing the "Up" or "Down" arrows.
- 2) Press the "VOL" button.
- 3) Depress either up or down keys respectively.
- 4) Control of volume will time out or press "CLAR" to close.

Intercom

To activate the intercom:

- 1) Press the "7" or "INTCM/XCV" keys
- 2) Depress a number key 1 to 8 for any specific control head or 0 for all control heads.

- 3) Depress the "7" button to disperse.

Control Head Number Display

To display control head number for 2 seconds (will be timed out after 4 seconds):

- 1) Press the "SHIFT/FUNC" button.
- 2) Press the "0" or "MODE" button.

Back Light

To turn back light on or off or adjust brightness level:

- 1) Press the "SHIFT/FUNC" button.
- 2) Press the "CHAN" button.
- 3) Press "Up" or "Down" arrows to step through available levels.

Noise Blanker

To turn noise blanker on or off (optional):

- 1) Press the "SHIFT/FUNC" button.
- 2) Press the "4" or "SPK" button.

Beep

To enable a beep for every key stroke:

- 1) Press the "SHIFT/FUNC" button.
- 2) Press the "5" or "TIMER" button.

Display (Date/Time)

To toggle between constant date/time display or to alternate date/time display:

- 1) Press the "SHIFT/FUNC" button.
- 2) Press the "6" or "CLOCK/DATE" button.

Delete

To delete last entry made:

- 1) While in programming mode, press the "SHIFT/FUNC" button.
- 2) Press the "7" or "INTCM/XCV" button.

Lockout

To lock out a channel in scan mode:

- 1) While scanning, wait for a channel to appear and press the "SHIFT/FUNC" button.
- 2) Press the "8" or "20 dB/ATTN" button.

FWD / SWR

To toggle forward power and SWR display in transmit:

- 1) Press the "SHIFT/FUNC" button.
- 2) Press the "9" or "PWR/HI LO" button.

Transmit Channel Locking

The SG-2000 includes a provision in software for locking the radio into channelized operation only. We recommend that this function be invoked whenever you are using an SG-2000 in a maritime mobile situation where only one operator knowledgeable about direct entry of frequencies is aboard. In this way, the persons aboard the vessel, who might need to operate the SG-2000 in an emergency, need only be taught how to call for help on the desired emergency channels. Please note that the channels include major ham frequencies on the 75, 40 and 20 meter bands where distress assistance may be available. When the lock is invoked, reception on all frequencies is possible, but transmitting will only occur on programmed channels (including those which are user defined).

Lock for Channelized Operation Only

Use the following key sequence to lock out direct entry of transmit frequencies:

"SHIFT/FUNC", "8", "8", "CHAN"

Unlock Channelized Only Operation

Use the following sequence to enable transmit capability on all direct entry frequencies plus frequencies which are contained in channel memories:

"SHIFT/FUNC", "8", "7", "CHAN"



NOTE: If you are operating the SG-2000 aboard a vessel or in a mobile installation where channelized operation only is allowed, you may disable the all-frequency transmit capability of the SG-2000. You may not wish to disclose the unlocking sequence to some operators. Simply say that the radio is type approved for ITU channels and it includes reception capabilities for all frequencies. You will be able to demonstrate that it will not transmit on unauthorized frequencies.

Transmit Frequency Monitor:

To preview the transmit frequency, when operating in the semi-duplex mode, press the "SHIFT/FUNC" button, then press the "CLAR" button and hold it down. The radio will then monitor the transmit frequency. To return to the normal receive frequency, release the "CLAR" button.

Temporary Settings:

The SG-2000 will store current settings on a temporary basis so they may be easily recovered after changing radio parameters. To temporarily store settings, press the "PRGM" then "SHIFT/FUNC" buttons. To recover these temporary settings, press "SHIFT/FUNC" then "PRGM."

14.0 Mobile Installation

Many tips regarding mobile installation have been given in the preceding chapters, but such a large and important field warrants its own chapter.

14.1 Shock and Vibration Mounting

The need for shock mounting is widely misunderstood in radio circles. There are two issues with regard to shock mounting which must be considered: physical displacement and frequency.

Displacement is how far a unit moves when vibration occurs. In a vehicle, this may be a small fraction of an inch. The displacement on a sailboat can be 20 feet – if the vessel is operating in 20-foot seas.

Frequency is how often a change of direction takes place. On a vehicle, frequencies may run up to many times per second, while on a sailboat the frequency may be one cycle in 2 minutes. A high speed paramilitary RIB (Rigid Inflatable Boat) might encounter shocks at 1 per second, or greater rates depending on sea state and mission. This requires shock mounting.

To estimate whether a shock mounting is required in a particular installation, multiply the frequency (in cycles per second) times the displacement (in inches). If the resulting number is greater than three, a shock mounting tray should be considered. With a value over five, a shock mounting is mandatory.

Let's look at the sailboat numbers:

In a 10 foot sea, with a wave period of 1 minute, the calculation is:

120" times 1/60th of a cycle per second = a vibration factor of 2.

So in this case, installation of a shock mount is not necessary.

But let's look at what happens on a military four wheel drive vehicle racing across the back country at 60 miles per hour. Here, the displacement can be 3 inches and the frequency up to 2 times per second. In this case, the calculation would be:

3 inches times 2 = a vibration factor of 6.

A shock mount is obviously needed. But let's consider a family vehicle driven on average city streets and highways. Here, displacement would be 1/2 inch or less. This means a calculation of:

.5 inch times 2 = a vibration factor of 1.

In other words, unless you are planning extraordinary abuse of a vehicle, a shock mount is not necessary. But if you run back country roads with 5 inch deep chuck holes which cause a vibration factor over 3, a shock mount is required.

In addition to shock and vibration considerations, the mobile environment brings with it two additional issues which need to be addressed before satisfactory operations will be attained.

One is the ground system; the other is ignition noise.

14.2 Mobile Grounds

"They don't build 'em like they used to" is certainly true about today's automobiles. Not only do they have more wires, which can pick up stray RF, but there are also generally fewer welds which means the ground system presented by the vehicle may not be of high integrity. As a result, ground loops may occur, and in some situations, reduced radiation efficiency due to a smaller ground system. Here are some guidelines which will eliminate some ground issues.

1. Keep all wire runs as short and direct as possible. This means keeping the path direct. It is especially important to keep the antenna wire from the SG-230/SG-235 coupler as short as possible to the external mobile antenna (the SG-303 is recommended). Because the hot wire off the antenna coupler terminal is where the antenna begins, if you have 12" of antenna wire inside the vehicle, and you are using a 9 foot whip, 10% of your antenna is inside the vehicle where it will not radiate and will be susceptible to noise from vehicle systems.
2. Use the largest wire size practical for power wiring. SGC recommends that power lines from the battery to the radio be at least #6 gauge stranded wire and that the ground of the battery be cleaned periodically to make as good a connection as possible. Wire runs will cause loss. SGC does not recommend any 12 VDC run of more than 25 feet.
3. The ground from the radio chassis, from the coupler ground post, and from the battery minus terminal should all be attached in two places, preferably using braised wire of #0. The connection to the vehicle chassis should be cleaned of paint and should be scraped to reveal raw metal. If corrosion is likely to be a problem, you may fasten the ground system very tightly using self tapping sheet metal screws and large copper washers (to give maximum surface contact) then lightly dust the area with Krylon™ matte finish or other clear varnish type finish to provide some corrosion protection.

4. The doors, hood, and truck lid should all be grounded to the vehicle using size #0 (AWG) braid or larger. It is important that all parts of the vehicle be bonded together in this fashion.
5. Take care to ground the vehicle exhaust pipe in several places. If the exhaust pipe is only partially grounded and vibration is encountered, the vibrating tail pipe can cause irritating noise.
6. For vehicles which are operating in areas of dry, blowing sand, there is occasionally static build-up on the vehicle relative to ground. You may also encounter this phenomenon in a vehicle operated in cold dry climates in the winter months. You may use either a static spray (such as is sold in department stores for use on clothing) or other commercially made products to reduce static.

Tires rolling on pavement may produce static electricity under certain conditions. Although not usually encountered on vehicles using semi-metallic brake pads and disk brakes, it has been known to happen on older style large military vehicles where the axle shaft is insulated from the wheel. Commercial brush kits are available to resolve this condition should it be encountered.

7. Don't assume that your vehicle bumpers are made of metal. Automobile bumpers are being made out of plastics and plastic-filled metal shells which attach to the vehicle using electrically unreliable fasteners. In many cases a metal bumper looks like it should be grounded, but in fact it is not.

There is a simple reason why this happens: some vehicles have the bumpers put on at the assembly plant after a coat of paint or protective finish has been sprayed on the body. This good engineering plan for rust prevention is not acceptable for HF radio work because the paint layer may not be scraped by tightening the bolt and this may result in a poor connection or no connection at all.

8. If you are installing the SG-2000 in a remote head configuration, it is not necessary to ground the control head with a separate cable. The control head and the RS-422 data lines which are used for control of the radio need only be grounded at the control head plug on the radio in order to work properly. Installation of the control head with grounding should not cause problems, but if any unusual operations are encountered, the existence of a ground loop involving the control head should be investigated.

14.3 Vehicular Noise Sources

There are three kinds of vehicle noise which will be encountered. One is the ground/static noise which should be eliminated by following the proper grounding procedures noted above. Second is engine noise and third is accessory noise. Let's address these step by step:

1. Diesel engines do not make ignition noise. If you are fortunate enough to have a diesel which doesn't need high voltage spark plugs, you are one step closer to a perfect mobile set up. However, even in diesel powered vehicles, there is still an important source of engine related noise: the generator or alternator.

To eliminate a good deal of vehicle engine-related noise, it is good engineering practice to install RF by-pass capacitors at the battery and across the alternator terminals. The capacitor doesn't need to be especially large: .01 to .1 micro Farad disk ceramic capacitors with a working voltage of 100 V will do just fine. We recommend the use of non-polarized capacitors: these are simpler to install because polarity may be ignored.

2. Gasoline or natural gas-powered vehicles have high voltage wiring for ignition spark plugs which causes a small amount of radio frequency energy to be transmitted each time the cylinder fires. So, on an eight-cylinder car which is running at 3,000 RPM, there are 6,000 little sparks every minute. Four cylinder cars emit 3,000 sparks at the same RPM.

The key point of installation here is this: Get the antenna system as far away from the engine compartment as possible. This is why SGC developed the QMS (Quick Mount System). Not only does this keep the coupler to antenna wiring as short as possible, but it also puts another layer of metal between the noisy engine and the antenna base.

3. The noisiest wire in the vehicle is the lead from the ignition coil to the center conductor of the distributor and the wiring in the vicinity of the distributor itself. If you doubt this, we suggest you invest \$10.00 in the best mobile trouble shooting device made: a small cheap AM radio. All you need to do to "sniff out" 90% of the vehicle noises you will encounter is to put this little AM radio to the high end of the broadcast band (1610 KHz) and turn up the volume.

As you get the radio near the ignition wiring you will notice a marked increase in spark plug noise. Isolating the problem is the first step toward resolving a noisy engine.

The second step in the "cure" involves the use of what we call "Vitamin C," electrical capacitance. Applying a capacitor at the right location will

solve many problems you are likely to encounter.

4. Capacitors will bypass spikes of electricity, such as those pulses which run the spark plug to ground. Small capacitors are fine; however, if you add too much capacitance to ground, you will flatten the ignition spike and reduce the intensity of the spark. The arrival time of the spark will also be delayed because the capacitor which you use will slow the rise time of the spark pulse.

With too much capacitance, the spark voltage may drop from 20,000 volts to 5,000 volts which isn't enough to cause a spark in the engine. For this reason, the only place you want to put a capacitor is on the primary side of the ignition coil.

5. Shielding the distributor is the next most likely means to reduce noise. This may not sound graceful, but occasionally a brute force approach is needed.
6. Wheel static may be eliminated with brushes, and accessory noise may be isolated by turning on and off items such as heater fans and air conditioners.

15.0 Marine Installation

Installation of the SG-2000 in the marine environment requires considerable care in order to achieve highly reliable operation because while the SG-2000 is a very reliable radio, the marine environment brings with it unique problems. These fall into three general areas: Installation of the radio, obtaining a proper ground system, and use of a suitable antenna.

15.1 Marine Radio Mounting

The most common configuration of the SG-2000 in the marine environment is use of a standard mounting tray (SGC Part Number 52-46) and the remote head kit (SGC Part Number 04-12). With the control head detached from the body of the radio, the operating position may be made much more compact.

SGC does not presently provide a flush mounting kit for the SG-2000. Instead, we recommend the use of the remote head kit's gimbal mount. This allows for the control head angle to be changed to prevent glare off the display screen and allows individual operators to adjust the unit for the most comfortable operation.

In the event that you need to disconnect one end of the control head wiring in order to route cable, please disconnect the female plug end. Disassembly of the control head to remove wires from the control head is not recommended for inexperienced installers. If you do need to remove the plug to route cable, carefully note the connections of each wire. When the wiring is reassembled, care must be exercised to prevent wires from touching.

Power wiring to the SG-2000 should be through its own breaker. This breaker should be 30 amps and the routing of the wire should be as direct as possible.

The minimum wire size which should be used is number 6 (AWG). Wires should be both crimped and soldered to connectors prior to being attached to the power barrier strip. Connections at the D.C. panel should be securely made.

15.2 Marine Ground Systems

"Bonding," as it is called in marine circles, is the process of tying all vessel metal into a single electrical point. The reason for bonding is that for an HF radio antenna to radiate properly, a large counterpoise of more than 100 square feet of metal must be present under the antenna.

This is not difficult provided you are willing to invest a certain amount of time. The recommended bonding material is copper foil. Available in several widths, the foil should be routed to keep all leads direct.

SGC does not endorse the use of artificial ground plates as a replacement for an adequate bonding system. While such plates, generally made out of a porous zinc alloy, provide some grounding, they are also subject to corrosion and marine growth which reduces their efficiency. There is no substitute for copper foil and lots of it!

On FRP (fiberglass) hulls, a good connection to the sea may be made by routing foil as close to the hull as possible. When you have a large foil surface inside the hull, separated from the sea water by less than 1/2," a capacitor is formed. This coupling is very effective. Remember, as far as RF is concerned, total area, not D.C. continuity, is critical.

Metal hulls are great, but remember if you are dealing with an aluminum hull that corrosion is a constant enemy. The best connections are welded to the aluminum and cleaned frequently because aluminum tends to corrode in the presence of dissimilar metals.

The best ground system is run down the chine, below the waterline, on either side, plus a run down the keel, picking up the engine block and all tankage possible in order to build a large surface area ground.

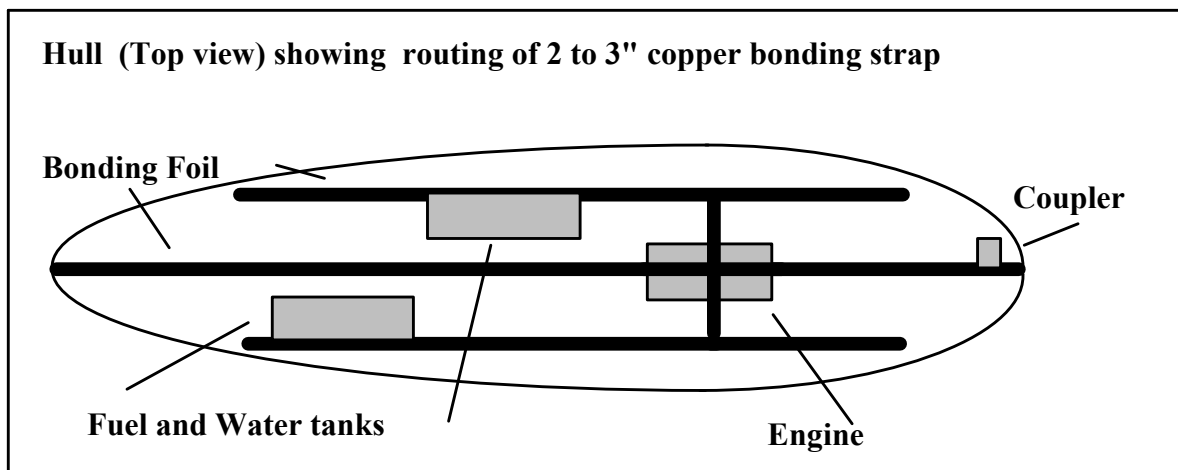

In addition to the large metal surfaces, you may also connect life lines and a metal toe rail (if available) to the bonding system.

It had been common practice for several years to put copper screening in the cabin roof and mount the HF antenna above the roof. While this worked well at high frequencies, the lack of capacitive coupling to sea water and the relatively small size of the ground surface, when compared with a large in-hull bonding system, make the copper screening approach less desirable.



15.3 Marine Antennas

In general, power boats use whip antennas and sailboats use back stay or triadic antennas. The placement of the antenna is not critical except that it should be kept at least 3 feet away from the rigging.

Please refer to the following diagram for sailboat antenna placement information:

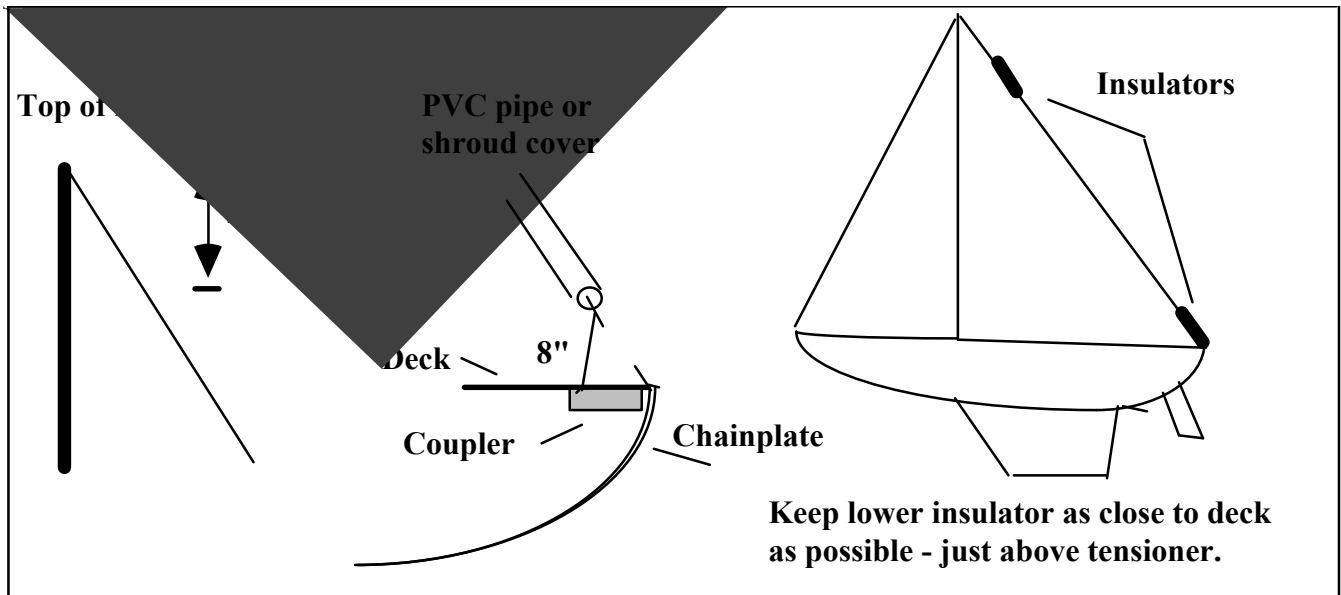

SGC recommends that the top insulator be placed 4 feet down from the top of the mast to reduce the risk of lightning striking the radio antenna. In addition, we recommend placing the lower insulator as close to the deck as possible and covering the exposed backstay with a piece of small diameter plastic pipe (or a slip-on shroud cover) to prevent risk of an RF burn if the antenna is touched while transmitting.

15.4 High Seas Direct™ Connections

High Seas Direct is a system which allows over-the-air HF dialing from a single sideband radio transceiver from anywhere in the world into the AT&T long distance telephone system via AT&T Maritime Services stations WOO, WOM, and KMI.

While the AT&T descriptive literature covers some aspects of the service and operation of the dial modem units, you or your marine radio technician will need the following information to connect the AT&T system to an SG-2000:

The AT&T High Seas Direct product consists of two units: a handset which is mounted near the radio; a modem unit which is typically installed in a less accessible area. The following pin out information is provided:

On the High Seas Direct™ Modem Unit there are four connectors:

1. Modem Power Supply Connections

(Supplies power for High Seas Direct Unit)

Pin	Item
1	Live 12/24 volts DC
2	Earth (Ground)
3	Ground

2. Modem RS-232 (DB-9) Connector

(Provides connection to serial devices)

Pin	Item
1	DCD
2	RX data
3	TX data
4	DTR
5	Ground
6	Fax
7	Relay contact
8	Relay contact
9	Ground

3. Modem Connector to Radio

(Provides connection from Modem to SG-2000)

Pin	Item
1	Common
2	PTT out
3	Mic Out
4	Audio In
5	not used
6	Ground (PTT and radio)

Pin	Item
1	Common mic
2	PTT In
3	Mic In
4	Audio Out
5	Scrambler activate
6	Ground PTT & Audio

Modem to Radio Connections:

High Sea Direct Modem			SG-2000 SSB Transceiver	
Radio Port			J301 Rear Panel Conn	
Pin	Item		Pin	Item
2	PTT	<--connect-->	4	PTT
3	TX Out	<--connect-->	1	Audio In
4	RX In	<--connect-->	3	Audio Out
6	Ground	<--connect-->	2	Ground

16.0 Remote Control

There are three primary methods of controlling the SG-2000. One is by extension of the control head wiring. Second is via short haul modems and auto-answer telephone interface equipment. Third is via computer network and auto-answer devices. The first method does not require any additional equipment. The second two require the addition of the SG-2000 RS-232 option (SGC Part Number 52-34)

SGC does not warrant the remote installation of any unit in configurations which exceed the 50 meter limit of the RS-422 standard used by the local area network between control heads and the radio. This is not because extended operations do not work, but rather because the distance between units blurs the responsibility between the operator of the computer system and the provider of the transmitter. As you can appreciate, the SG-2000 operates on a wide range of platforms including networks which directly access the serial port.

If you are planning to operate the SG-2000 under control of the RS-232 software supplied by SGC, please refer to the Accessories and Software portions of this manual for additional information. ALE and serial control as applicable to adaptive controllers is covered in its own section.

16.1 Extension of Control Head Wiring

The SG-2000 specifications call for remote control heads to be located within 50 meters (approximately 162 feet) of the radio's main unit which houses the receiver, transmitter, and two of the three microprocessors plus the RS-232 and RS-422 serial communication devices.

We have had reports that control heads have been operated at longer distances, approaching in one case to more than one kilometer, but with slightly degraded performance. The performance degradation which was noted included a slight hum being added to the audio in both receive and transmit and, during severe lightning storms in the immediate area, intermittent operation of the frequency and mode controls.

The method used to extend the control head wiring, in this instance, was to find a spare 25 pair shielded telephone line and then simply replace the 10 wire control head wire with appropriate pairs. The most important portion of this kind of installation is to provide a good DC loop for the Push-to-Talk (PTT) circuitry.

16.2 Short Haul Modems/Auto-Answer Devices

The second way to achieve remote control of the SG-2000 is to use a number of telephone lines and a short haul modem. The configuration is basically the same as the extension via telephone wiring, described above, but short haul modems (1200 baud) are used to improve the reliability of the computer data which is exchanged between the control head and the main radio unit.

The audio and PTT circuits may be extended using either separate wiring and a voice-operated transmit telephone patch, such as the SGC TEL-TWO (SGC Part Number: 52-75), and a separate DC loop for PTT control, or by installing three pairs for audio: Two for receive, two for transmit, and a PTT pair. (Please see AUTO-ANSWER DEVICES below.)

16.3 Line of Demarcation

SGC has found it important in all remote control installations involving the SG-2000 and PRC-2250 series radios to make clear from the outset of design and installation that the responsibility of SGC is to provide the highest quality radios available. However, the responsibility of SGC does not extend to design of computer networks, microwave networks, fiber optic systems, or telephone systems which are used to control the radios unless specifically negotiated and agreed to in advance.

The distinction is this: SGC and its world wide dealers are responsible for provision of equipment only and do not provide system design or warrant operations beyond the specifications of the radio equipment. The lines of demarcation (or "demark" in telephone company terminology) is as follows:

Remote Control:	RS-232 (DIN-9) plug of SG-2000/PRC-2250
Remote Audio:	J-301 rear panel of SG-2000/PRC-2250
Push to Talk:	J-301 rear panel of SG-2000/PRC-2250

SGC is not responsible for providing integration with networks, devices, and systems which are beyond demark.

SGC and its dealers do not provide system integration with complex networks. Such services may be undertaken from time to time by either SGC or its dealers, but arrangements to do so are always separate agreements from supply of radio equipment.

16.4 Auto-Answer Devices

Particularly when used by a network, the SG-2000 needs to get audio for transmit and needs to send receiver audio somewhere. In order to accomplish this, the radio is usually equipped with a telephone patch such as the SGC TEL-TWO system. This unit incorporates a voice-operated-transmit (VOX) circuit which provides automatic switching from transmit to receive when the telephone user is listening and provides automatic activation of the transmitter when the telephone user begins to speak.

The SGC TEL-TWO does not, however, provide a means of taking the telephone drop equipment (called the "instrument" by consumers) to an off-hook condition. This is because there are hundreds of telephone systems in the world today and most of these are the new digital type. The particular signal level and signal type which signals an "off-hook" condition to the digital switch is different from the old fashion analog auto-answer scheme used in earlier telephone systems such as the Western Electric 1A2 keyset variety.

For this reason, you will need to contact your telephone equipment provider to insure that an auto-answering system is available for your telephone switch. If you are using leased or dedicated pairs of phone lines for the circuit, such as at a remote site, you may wish to construct a simple auto-answer circuit yourself, if one cannot be provided by the local telephone company. Another option is to use additional pairs and isolate functions to eliminate the need for the phone patch.

Circuit particulars will vary as widely as do telephone systems used throughout the world.

16.5 Computer Networks - Serial Control

The SG-2000 may be controlled by a computer at the radio site by simply connecting an appropriate serial line between the radio's rear panel "D" connector, labelled RS-232, and the serial port of the IBM PC computer. We prefer that the radio use COM-1, as COM-2 is generally used by telephone modems.

If your plan includes access via modem, SGC supports the Norton pcAnywhere™ remote computer software and the SG-2000. The process to begin operation of the system is simple. pcAnywhere is started and the modem is connected on COM-2. When pcAnywhere is running, the program SG2000.EXE is started and will seek the first available serial port (generally COM-1) and will initiate communication with the radio. This is covered in more detail in the RS-232 documentation.

If you are operating a computer on a local area network, you may access the serial port directly, if this is supported by your local or wide area network. If this is the case, please refer to the section of the SG-2000 manual which covers



details of ALE (adaptive HF controllers) and serial port communications.

17.0 External Software

This section lists information on the RS-232 software, called Softlink, available for the SG-2000.

17.1 RS-232 Serial Control Software

The RS-232 allows the SG-2000 to be fully controlled by a computer terminal (PC, IBM compatible, or laptop). Via the RS-232's control lines, the computer (in essence) becomes the control head for the SG-2000. The SG-2000 can now be controlled by eight computer terminals, or by eight remote control units, or any combination of the two. Any function dealing directly with audio (volume, speaker on/off, squelch, etc.) will not be controlled by the RS-232 since this does not apply to the operations of the computer. For data communications or monitoring purposes, the RS-232 connection enables this to be a smooth and user friendly process.

The SGC RS-232 software system provides for direct computer control of the popular SG-2000 all band solid state HF transceiver. Because of its advanced design, the SG-2000 may be configured to support any combination of up to eight computers and control heads. This means, in a typical installation, that you may have six control heads and two computers controlling the same SG-2000.

This tremendous versatility makes the SG-2000 with DOS software the radio of choice in numerous commercial, marine, paramilitary, and amateur applications.

Audio functions of the SG-2000 such as volume, speaker on/off, and squelch, are not controlled by the RS-232 software: these functions are not supported by current IBM compatible computers.

In addition, it is important to note that the software allows operation of the SG-2000 without a control head. This configuration is desirable in installations where audio or analog data streams can be best handled through other systems.

For data communications or monitoring purposes, the RS-232 facility ensures crisp, reliable, user friendly control of the radio. Version 1.0 of the software does not include ARQ or other data communications, because separate software is available for this specific purpose.



17.2 RS-232 Software Installation

This section outlines system requirements, equipment setup, software installation, and troubleshooting information.

SGC software is shipped on a 3.5" disk although 5.25" is available upon request. You may install the software on a hard disk or you may run it directly from the product disk. If you decide to operate from the floppy drive, we recommend that you make a backup copy of the product disk we provide and keep the original in a safe place. See your DOS manual for instructions on how to make copies of software.

1. System Requirements

The system requires an IBM or 100% compatible computer operating with DOS versions 3.0 or greater and one free RS-232 port available as COM1 or COM2. If you have questions about the availability of these ports, contact your computer hardware vendor.

If you need to find out what version of DOS is in use, return to any prompt (the C:\> prompt for example) and type:

VER [enter]

The computer will then respond with the version number of DOS which is running.

2. Setup

Plug the female end of the RS-232 cable into the computer COM port (either COM1 or COM2) and the male end of the cable into the SG-2000 RS-232 port.

Turn on the SG-2000.

Boot up the computer.

Insert the SG-2000 software disk into the appropriate drive. See the following sections for specific installation instructions for both floppy drives and hard drives.

Switch the computer to the drive that contains the SG-2000 software if necessary.

Type:

SGC [enter]

on your computer keyboard. You will be presented with the software Main



Menu.

3. Running Software from Floppy Drives

To run the software on the product disk, place the disk in Drive "A" (for 3.5" floppy). Now change to the "A" drive by typing:

A: [enter]

The computer will respond with the following prompt:

A:\>

Type the following command at the A:\> prompt to begin the software:

SGC [enter]

4. Hard Disk Installation

To install the software on your hard drive, place the program disk in Drive "A" (for 3.5" floppy) of your computer.

Change to the "A" drive, if you are in some other drive, by typing:

A: [enter]

The computer will respond with the following prompt: A:\> Now type:

install [enter].

You will be prompted through the installation process.

In the event you do not wish to use the installation program which is supplied, please refer to your DOS manual and copy the file:

SGC.EXE

to the desired directory on your hard drive. The program is started by typing SGC [enter] at the appropriate DOS prompt.

5. Terms, Conditions, and License

A. SGC software is provided under the following terms and conditions of sale and license:

1. This software is for use on only one computer.
2. One back up copy is permitted.
3. Title to the medium is transferred to the customer but SGC, Inc. retains all title to the software.
4. Customer is expressly prohibited from disassembly of the



software without written authorization from SGC.

5. Customers may sell unmodified copies of the software provided that the customer has purchased one copy for each copy sold.
6. All copyright notices shall be retained on all copies of the software.
 - B. SGC, Inc shall be absolved from all liability resulting from the use of this software. SGC's sole liability will be for free replacement of damaged software.
 - C. SGC, Inc. reserves all title to the software which is copyrighted property of SGC, Inc.

6. RS-232 Software Troubleshooting

- A. **PROBLEM:** When I type "SGC" (and enter) the computer responds with "Bad Command or File Name".

SOLUTION: Make sure you have logged onto the drive containing the SG-2000 software.

- B. **PROBLEM:** When I type "SGC" (and enter) the computer flashes a message "Communications not established, please check connections and try again."

SOLUTION: Check cable connections first. If all is well, then the next most probable cause is that one of the cables you have tried using is a null modem cable. If this is the case, either replace the cable with a standard one or exchange pins 2 and 3 on one end of the null modem cable.

7. SG-2000 RS-232 Software Technical Support

All current changes to this software may be found in the ASCII file titled READ.ME which is included on the software disk.

We hope you do not encounter problems operating our SG-2000 software, but in the event you do, software technical support is available Monday to Friday from 8:00 AM to 5:00 PM Pacific Time at the following:

Voice: (206) 746-6310

Fax: (206) 746-6384



17.3 RS-232 Software Main Menu Display

When the software is started, the Main Menu is displayed:

Channel 99	Mode A3H	Time 14:32:50
RC FREQ 3860.0		
TX FREQ 3860.0		
	VOC USB	
FWD Power	Power Setting HIGH	
MENU 1		

[A] CHANGE CHANNEL	[F] ATTENUATOR
[B] CHANGE FREQUENCY	[G] EMERGENCY ALARM
[C] PROGRAM	[H] 2182 EMERGENCY
[D] SCAN	[I] PREVIEW TX FREQUENCY
[E] CHANGE MODE	[J] MENU 2

Radio operating parameters are displayed as follows:

Operating channel _____	<i>Upper left corner</i>
Receive Frequency _____	<i>Upper left corner</i>
Transmit Frequency _____	<i>Upper left corner</i>
Active Mode of Operation _____	<i>Upper center</i>
Current Date _____	<i>Upper right corner</i>
Current Time _____	<i>Upper right corner</i>
Active audio filter _____	<i>Middle right side</i>
Active Sideband _____	<i>Middle right side</i>
Meter selection _____	<i>Above left menu</i>
Power setting _____	<i>Above right menu</i>

17.4 RS-232 Software Main Menu Operations

The following operations are accessible from the Main Menu (see page 92).

A. Change channel

Press "A" then enter the desired channel you wish to use.

B. Change frequency

Press "B" then enter the new frequency or use the 'up' or 'down' arrows to step through the frequencies. Transmit and receive frequencies may be selected independently if desired.

C. Program Radio Functions

Press "C" and the software will present a sub menu which will prompt you to enter specific information as follows:

Program Sub Menu

[A] SCAN BANK	[E] FREQUENCY STEP
[B] TIMER	[F] TIME
[C] CHANNEL	[G] DATE
[D] SCANNING RATE	

NOTE: This sub menu is covered in Section 17.6, "RS-232 Software Programming Functions."

D. Scan

Press "D" and the Scan Menu is presented:

[A] FREQUENCY
[B] CHANNEL BANKS

For either frequency or channel bank scanning use the up or down arrow to change direction of the scan. To stop scanning, simply press the space bar.

E. Change Mode

Press "E" and you will toggle through various modes of operation.

F. Attenuator

Press "F" to activate or deactivate the 20 dB attenuator.

G. Emergency Alarm

Press "G" to enable the two-tone alarm generator on the 2182 KHz emergency channel. **WARNING:** This option will transmit an emergency alarm on the international distress frequency. For this reason, you will be asked to confirm this selection before the transmission is implemented.

H. 2182 Emergency

Pressing "H" will automatically transfer you to the 2182 KHz emergency channel. This selection will not activate the two tone generator.

I. Preview TX Frequency

Pressing "I" will enable you to monitor the transmit frequency in order not to transmit on a frequency that is already in use.

J. Menu 2

Pressing "J" from the Main Menu will enable you to use the second menu. These options are described on the next page.

[A]USB/LSB	[E]TIME / DATE
[B] NOISE BLANKER	[F]VOC / TLX
[C]POWER METER MODE	[G] TIMER
[D]POWER LEVEL	[Q] QUIT

17.5 RS-232 "Software Menu 2" Operations**A. USB / LSB**

This selection toggles between upper sideband and lower sideband.

B. Noise Blanker

This selection allows you to enable the noise blanker to block any and all unwanted intermittent noise pulses. (If the optional noise blanker has been installed).

C. Power meter mode

This selection toggles between FWD power and SWR.

D. Power level

This selection toggles operation between high and low power.

E. Time / Date

This selects display of either the current time or date.

F. VOC / TLX

This selection chooses either the voice or data audio filter.

G. Timer

This selection enables you to activate or deactivate the timer.

H. Quit

This selection allows you to quit the program.

17.6 RS-232 Software Programming Functions:

Pressing "C" on the Main Menu presents a sub menu which will prompt you to enter specific information as follows:

Program Sub Menu

[A] SCAN BANK	[E] FREQUENCY STEP
[B] TIMER	[F] TIME
[C] CHANNEL	[G] DATE
[D] SCANNING RATE	

A. Scan Banks:

Enter the desired Scan Bank to program.

B. Timer:

The following sub menu is presented to allow you to program the radio to "wake up" at a preset time and operating in any specified mode.

Program Timer Menu

[A] SET ON & OFF TIME
[B] ON CHANNEL
[C] ON FREQUENCY

1. Press "A" to enter the timer's on and off time.
2. Press "B" to enter the desired timer's on channel.
3. Press "C" to program the on frequency .

Selecting option "C" on the Program Timer Menu presents the following menu to set the radio's "wake up" frequency and mode:

Enter on Frequency	[A] MODE	A3H
RX FREQUENCY 0.0	[B] AUDIO FILTER	VOC
TX FREQUENCY 0.0	[C] SIDE BAND	USB
	[D] ATTENUATOR	

Enter the desired parameter by depressing the appropriate letter. Select the receive frequency and press return; select the transmit frequency and press return to end function.

C. Programming a channel.

The SG-2000 supports up to 100 user defined channels. Select the desired channel you wish to program then all of the parameters in the following manner:

CHANNEL	[A]	MODE	A3H
RX FREQUENCY 0.0	[B]	AUDIO FILTER	VOC
TX FREQUENCY 0.0	[C]	SIDE BAND	USB
	[D]	ATTENUATOR	

First enter the desired channel you wish to program. Select the desired parameter by depressing the corresponding letter. Enter the receive and transmit frequencies. Press return to end function.

D. Scanning Rate:

Program the scanning rate by using the 'up' or 'down' arrows to increase or decrease the rate of scan.

E. Frequency Step:

Program the frequency step by using the 'up' or 'down' arrows to increase or decrease the step in frequency. A display of .5 means that frequency changes are made at .5 KHz increments. A step of 5 means 5 KHz steps, and so forth.

F. Time:

Program the time in the following format: hr : min : sec.

G. Date:

Program the date in the following format month-day-year, i.e., 01-01-92.

17.7 PC Cable Assembly

The SG-2000 is can controlled by a computer – see the previous sections. However, computers can come with either a 9-pin or a 25-pin RS-232 connector as the COM port. The pin-outs are different between these two connectors; therefore this section will show how to construct a cable assembly to connect an SG-2000 to a computer using either variation.

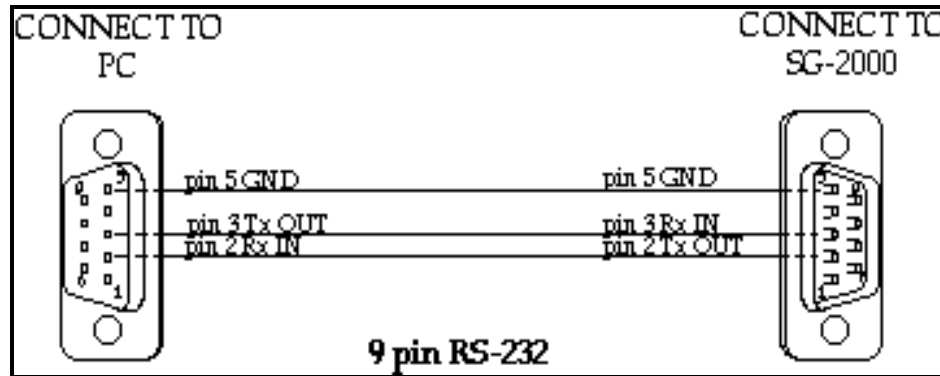

The figure above graphically represents the connections needed between a 9-pin male connector to be connected to the 9-pin RS-232 socket on the back of the SG-2000 radio and a 9-pin female connector to be connected to the 9-pin RS-232 plug of the computer's COM port.

The figure below represents the connections needed between a 9-pin male connector to be connected to the 9-pin RS-232 socket on the back of the SG-2000 radio and a 25-pin female connector to be connected to the 25-pin RS-232 plug of the computer's COM port.

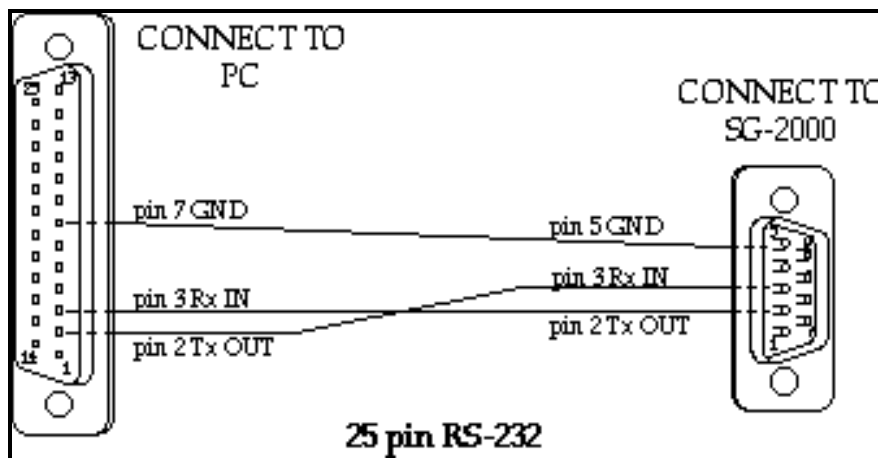

This cable assembly is not supplied by SGC. This information is furnished solely for customers to successfully build their own cables. However, a standard modem cable with a 9-pin male end and either a 9- or 25-pin female end (available both ways) is normally set up this way and will function efficiently if these three wires are verified to be connected as shown.

Note:

A null modem cable can be made to work by changing the orientation of J3 on the SG-2000 MicroProcessor assembly as follows:

1. Remove the top cover of the SG-2000.
2. Note the orientation of the 3 pin connector (J3) which is at the end of the wires coming from the rear panel RS-232 connector.
3. Unplug the 3 pin connector (J3).
4. Rotate J3 180 degrees and re-connect it.
5. Re-install SG-2000 top cover.

18.0 ALE and Adaptive Controllers

AUTOMATIC LINK ESTABLISHMENT - ALE

N O T I C E :

The SG-2000 radio as described in this manual is not a controlled export item. ALE controllers provided by SGC or other vendors which incorporate link protection systems **are** export controlled technology. *THE EXPORT OF THESE ALE CONTROLLERS REQUIRES A STATE DEPARTMENT EXPORT LICENSE. SGC WILL NOT SHIP ALE EQUIPMENT TO DESTINATIONS OUTSIDE THE UNITED STATES AND ITS TERRITORIES WITHOUT APPROPRIATE DOCUMENTATION IN FILE AT SGC HEADQUARTERS ON BELLEVUE, WASHINGTON.*

This section provides information on serial port operation of the SG-2000 and is directed toward users of ALE and adaptive HF radio controllers. The information in this document, however, applies to all serial port applications based on the SG-2000 platform. This section is not intended as a definitive ALE operations manual; that is contained within the SGC HARDLINK™ ALE documentation .

ALE is a technology which was defined by the MITRE Corporation, a federally funded non-profit research and development corporation in Washington, D.C. as Federal Standards 1045 through 1049 and in the Military Standard 188-141A.

The ALE technology relies on the marriage of two new technologies: multi-frequency modems and digital signal processing.

Where normal radio teletype modems send two tones, which are turned off and on, or shifted in frequency to achieve data communications, the multi-frequency modem within an ALE controller uses eight tones spaced 250 Hz apart and extending from 750 to 2500 Hz in the audio range.

By interleaving data between tones, and by turning tones on and off in particular sequences (called Golay interleaving) the integrity and recoverability of the information is greatly enhanced. Then, by using a digital signal processor to recover the tones, exceptionally robust data communications is achieved in conditions where a normal signal (either voice or CW) would not be recoverable.

The data stream which is first established between ALE stations is called the ALE orderwire. It is designed to pass network traffic and to introduce standards beyond FS-1045 for network administration including text store, forward, and other enhanced data operations.

18.1 SG-2000 Serial Port Operation

The SG-2000 can operate under the new U.S. Government Automatic Link Establishment protocol defined under standard FED-STD-1045 and under the military standards MIL-STD-188-141A. The SG-2000 will operate at both the 2 channels per second scan rate and the 5 channels per second scan rates defined by the standard.

An ALE station comprises an ALE controller unit, a high performance HF SSB radio, and support peripherals. These peripherals may include a dumb ASCII/ANSI terminal or an IBM PC or AT capable of emulating a dumb ASCII terminal.

The ALE unit, used in conjunction with an SG-2000, performs link quality analysis (LQA) on the ALE signals between stations. LQA information is used in selection of the best channel for calling and communicating. The ALE controller automatically identifies the best channel to speed connections and to provide optimum performance. Quality information on other channels is logged for future reference.

In addition, when under ALE control, the SG-2000 will not interfere with active ALE traffic channels and will exchange LQA information only with other stations when requested.

The significant advantages of ALE are obtained through the use of forward error correction, (Golay) data interleaving, and redundancy to enhance performance and to provide for error free message traffic. The ALE controller utilizes a digital signal processing unit to perform various linking, analysis, and signal processing functions.

The controller can retrieve and operate on up to 100 channels. These may be selected from any of the preprogrammed memories within the SG-2000 or may use the user defined channels or any combination of preprogrammed and user defined channels.

When not linked, the ALE configured SG-2000 will continuously scan a preselected series of channels, listening for ALE calls, and will be ready to respond. The scanned channels are selectable in groups or individually within a group to provide total flexibility in channel and network management. The scan rate of the ALE controlled SG-2000 is either 2 channels per second or 5 channels per second.

If an ALE system is linked, and operation of the link is disrupted through random noise or deliberate jamming, the controllers will establish communications on another channel. *This function, called link protection, is controlled export technology and may not be exported to other countries without a permit issued by the U.S. Department of State. In addition, export of ALE controllers to certain countries is banned. Contact SGC directly for the current list of banned countries.*

The controller supplied by SGC will provide for three modes of orderwire. These three modes use a low speed 75 baud data circuit which operates substantially below the lowest usable voice channel quality by application of digital signal processing to literally pull signals out of the noise.

The Automatic Message Display allows for the display of alpha-numeric text messages of up to 80 characters in length. The Data Text Message mode allows stations to communicate messages between any selected stations for direct output to or from associated DTE devices. (This facility also allows for error-free transmission of text files and computer files which include the full ASCII character set.) The Data Block Message mode is a high speed means of transferring orderwire messages with improved performance against long fades, noise bursts, and – to a degree – electronic counter measures.

18.2 Serial Communication Protocol

The SG-2000 communicates with the ALE controller via a serial communications port on the controller and the RS-232 serial port (D-subminiature 9 pin connector) on the rear panel of the SG-2000. The SG-2000 serial line parameters are preset to 9600 baud, 8 bits, no parity, and one stop bit.

All SG-2000 remote control commands consist of five parts as follows:

1. The "ATTENTION" signal. This consists of forcing the serial control line into a "break" (or "SPACE" [+V]) condition for a period of approximately 10 mS. This is then followed by a similarly 10 mS. period of a "MARK" [-V] condition.
2. ID/Byte Count. This consists of a single 8 bit character. The upper 4 bits should be set to zero to identify this as a command from a "computer" interface. The lower 4 bits are used to indicate the number of bytes to follow but not including the checksum byte. The range of this value will be from 01 (byte 1) to 0F (byte 15).
3. Command Code. The ALE controller requires the use of only three of the many commands available under the SG-2000 control system: RESET, STORE, and RECALL.



The RESET command (80) is issued as power up and whenever the ALE controller is switched between on-line and off-line conditions.

The STORE command (84) is utilized to upload frequency and mode data into a selected memory within the SG-2000 for future recall. This command is issued whenever the system operator changes a channel memory value from within the "Channels" menu on the ALE terminal.

The RECALL command (81) is the most commonly used command when the SG-2000 is under ALE control. It is typically issued two to five times per second as the ALE controller directs scanning through a selected group of channels. It is also issued during ALE calling as the controller will automatically attempt to select the best channel for an ALE link, using as its decision authority, the output from the Link Quality Analysis portion of the controller.

- 4. Command parameters (if any). These bytes contain further data which may be required by a particular command - such as Channel and Frequency values for the STORE command.
- 5. Checksum. This consists of a single 8 bit value which is created by adding together the values of command code and all command parameter bytes. Note that this value is not to be included in the total count of bytes specified within the ID/Byte Count number.

18.3 ALE Controller - Command Examples

Example 1: To reset or restore radio:

01	80	80
ID/Count	Reset	Check-
1 byte Command		sum

Example 2: To STORE Tx/Rx Data into a selected user definable memory within the SG-2000:

[0A]	[84]	[15 00]	[56 34 12]	[56 34 12]	[44]	[15]
ID/Cnt	Store	Channel	Rx Frequency	Tx Frequency	Mode	Check
10 Bytes	Cmd	(15 shown)	(12.3456 MHz.)	(12.3456 MHz.)	(USB)	sum



18.4 Recall a Selected SG-2000 Memory into Active Use

[02]	[81]	[17]	[98]
ID/Count		RecallChannel #	Checksum
2 bytes	Command	(17 Shown)	

18.5 SG-2000 Connections to ALE Controller

Connections between the ALE controller and the SG-2000 are listed in the manual for the ALE controller. For reference, the primary connections are as follows:

ITEM	Controller Pin	SG-2000 Pin
Transmit Audio	J4-4	J-301-1
Ground	J4-8	J-301-2
	J4-9	J-301-2
Receive Audio	J4-5	J-301-3
Push to Talk Keyline	J8-18	J-301-4
	J8-11	J-301-4
RS-232 Ground	J8-3	"D"9-1
	J8-7	"D"9-1
RS-232 Data	J8-2	"D"9-3

In addition to the information on accessing the SG-2000 serial port which is contained in the serial port/ ALE section of this manual, the following is a list of the major function codes which are addressable via the serial port.

<u>LABEL</u>	<u>HEX</u>	<u>FUNCTION</u>
RESET	80H	RESET AND RESTORE DISPLAY
RCALL	81H	RECALL CHANNEL FROM MEMORY
RVIEW	82H	REVIEW USER MEMORY CHANNEL
RSTOR	83H	RESTORE RADIO TO DISPLAY
STORE	84H	STORE CHANNEL IN USER MEMORY
LDFRQ	85H	LOAD FREQUENCY
LDCLK	86H	LOAD CLOCK
LDDTE	87H	LOAD DATE
EMFRQ	88H	LOAD EMERGENCY FREQUENCY
STCLC	89H	STORE CLEARED CHANNEL
SMODE	8AH	STEP RADIO MODE
TSBFL	8BH	TOGGLE SIDEBAND FILTER
TVTFL	8CH	TOGGLE VOICE/TELEX FILTER
TATTN	8DH	TOGGLE ATTENUATOR IN/OUT



TXMTP 8EH	TOGGLE TRANSMIT POWER
TBLNK 8FH	TOGGLE NOISE BLANKER ON/OFF
SCSCR 90H	STEP CHANNEL SCAN RATE UP
SFSCR 91H	STEP FREQUENCY RATE UP
CLARIF 92H	CLARIFIER
RQXMT 93H	REQUEST TRANSMIT
CHSTP 94H	CHANNEL STEP
FQSTP 95H	FREQUENCY STEP
GTTME96H	GET TIME
GTDTE 97H	GET DATE
SVIEW 98H	REVIEW SCAN CHANNEL
STSCN 99H	STORE SCAN CHANNEL
TXEMF 9AH	TRANSMIT FREQUENCY ALARM
CHSCN 9BH	START/STOP CHANNEL SCAN
FQSCN 9CH	START/STOP FREQUENCY SCAN
SPSCN 9DH	STEP CHANNEL SCAN
SCNPS 9EH	SCAN PAUSE ON SQUELCH
PWMTR 9FH	TOGGLE FORWARD SWR READING
SCNPN0A0H	STOP SCAN PAUSE
LDTMR 0A1H	LOAD TIMER
LMRGL 0A2H	TOGGLE TIMER ENABLE
GTTMR 0A3H	GET TIMER
GTTOF 0A4H	GET TIME OFF
INCOM 0A5H	SET UP INTERCOM
PRMUP 0A6H	LOAD POWER UP FREQUENCY
PCHUP0A7H	LOAD CHANNEL UP
OBEEP 0A8H	CHANGE KEY BEEPER
SCONT0A9H	CONTINUE SCANNING
SWTFR 0AAH	TOGGLE REC/XMT FRQ
LKCHN 0ABH	LOCK CHANNEL
UNCHN 0ACH	UNLOCK CHANNEL
STSTG 0ADH	STORE
LSTSR 0AEH	LAST CHANNEL STORE RESTORE

19.0 Accessories

Two major accessories for the SG-2000 are the Digital Selective Calling system – Exsel-100 – and the Telerec error correcting radio communications data terminal unit.

19.1 Exsel-100 Selective Calling System

The SGC EXSEL-100 unit is designed to operate with the SG-2000 transceiver but may also be used with any high quality SSB transceiver. The EXSEL-100 system may be configured as a standard unit, compatible with GMDSS CCIR-493 series operation. In addition, the EXSEL-100 may be further configured to operate under the new advanced protocols used by the Australian Overseas Telephone service, the so-called OTC Advanced signaling system. This capability will be especially appreciated by world cruising sail boats and by SGC customers in the outback of Australia.

CCIR-493 is used internationally under GMDSS, the Global Maritime Distress Signaling System. All of these systems use Digital Selective Calling (DSC) operation.

In selective calling, multiple radio receivers are used on a single frequency as a network configuration. Just as the telephone company assigns a telephone number to a particular telephone, each receiver in the DSC network is assigned a distinctive number. The distinctive number of each set is not operator-adjustable, but is readily changed in a matter of minutes by a qualified technician.

To call a particular unit, the sending operator dials the desired unit's unique code by setting thumb wheel number switches then pressing a spring loaded SEND button.

The receiver whose code has been sent will respond with a "handshake" tone so that the sender knows the call was received. At the distant receiver, a red light will turn on and stay on until the SEND/RESET button is toggled briefly to RESET.

The EXSEL-100 Unit is largely immune to false triggering and will operate under most adverse atmospheric conditions. In fact signaling is often better than voice, so you should not be surprised if you occasionally receive a call but cannot hear your party well.

The EXSEL-100 enclosure allows use in automobiles, or alternatively, in base station installations with transceivers other than the SG-2000. For installation with units other than the SG-2000, please refer to the EXSEL-100 Interconnection Diagram for required connections to the transceiver.

19.2 TELEREX™ ARQ/FEC/SELFEC System

The *TELEREX-ST* is an optional sophisticated microprocessor-controlled error-correcting radio communications data terminal. Despite its considerable capability, it is extremely easy for the unsophisticated operator to use.

It has been designed primarily for text communication in marine and land based point-to-point radio links and complies fully with CCIR recommendation 476-4. It incorporates (optional) Channel Free signal reception and generation, according to CCIR recommendation 492-3.

If you have purchased the associated IBM-PC driver software (optional) for the *TELEREX-ST*, you will be almost entirely insulated from the COMMAND code sequences which are dealt with at length in this manual. Only the initial sections, covering installation and set up, need be read. From that point, the software is menu driven. Unless you encounter specific problems, you should not need to refer to this manual further.

With care in installation and proper attention to the shielding and grounding of leads, the *TELEREX-ST* should provide many years of reliable service.

The *TELEREX-ST* connects between a radio transceiver and a computer or a dumb ASCII terminal. Data is passed to the *TELEREX-ST* by means of a serial RS-232 connection. The computer or terminal must be equipped with a suitable interface. The unit converts text entered from the terminal into encoded audio tone signals that are transmitted over the radio link. It also decodes audio signals from the radio into text to be passed to the terminal, automatically handling all transmit/receive changeover switching.

MIXED MODE (Voice-Telex) OPERATION NOTE:

When using the SG-2000 with the Telerex (or any other data controller), be sure to remove power from the Telerex unit when the voice mode is being used in order to avoid the possibility of transmitting both voice and data at the same time.

20.0 Answers to Frequently Asked Questions

The following is a short list of our more frequently asked questions:

1) Is there a charge for repairs out of warranty?

Radios are warranted for five years parts and labor. After this five year period, a minimal repair charge is assessed depending on the individual situation.

2) How can I hook up weather fax equipment?

There are two methods of hooking up weather fax equipment.

A) Attach to the J301 600? in/out port on the back panel of the SG-2000 chassis. Pin 3 is audio out, pin 2 is ground. Output level range is 500 to 800 mV RMS.

B) Speaker and headphone output:

1) Attach to J505 External speaker option on right side of back panel of the SG-2000 chassis. Pin 1 is audio out, pin 2 is ground. Output level is adjustable by the volume control.

2) If the control head is in a remote location, then J505 has been disconnected. In this case, you must remove the back plate on the control head and tap off from the speaker terminals and run wires through a hole in the back panel (you must drill the hole yourself).

3) Where does the CW key connect?

There are 2 locations (3 if the splitter box is included) to which you can connect a CW key:

A) J301 on the rear panel; pin 4 is PTT, pin 2 is ground.

B) Front panel microphone connector; pin 4 is PTT, pin 3 is ground.

C) Optional microphone splitter box which allows simultaneous hook-up of microphone, CW key, and headset (same connections as front panel microphone connector).

4) Are there any audio filters available?

The short answer is no, not in the SG-2000 itself. However, our new product, PowerTalk™ offers several types of digital audio filtering processes. See question 6.

5) What are the actual values represented by the bar graph?

Bar graph indications are for reference only and do not have a numerical equivalent. In CW mode, you should see almost all bars displayed on the forward scale. In voice, about half the bars displayed is normal. In reverse power position, 0 to 1 bar is normal if external coupler is tuned. In a non-tuned state, between 0 to 5 bars displayed is possible depending on degree of antenna mismatch.

6) Is a noise blanker option available?

For noise suppression, SGC recently introduced the PowerTalk™ head with ADSP™ noise suppression.

7) Can the SG-2000 be mounted in other than an upright position?

The SG-2000 head or chassis or complete unit can be mounted in any position, as long as there is sufficient clearance maintained for adequate air flow around the unit or chassis.

8) Practical tips for installation of radios/couplers on sailboats and motorboats.

Sailboats - use your backstay only, see section 15.3, page 82.

Motorboats - use the tallest whip antenna practical (28 feet; 23 foot antenna somewhat too short to be efficient). Also, use a long wire antenna if possible – 60 to 120 feet, the longer the better.

Radios with the head remoted - install the radio section of the SG-2000 next to the battery system.

Radios with the head attached - Install the complete unit as close to the battery system as possible.

Grounds on boats - use all metal structures tied together. If not feasible, use 3 to 4 ground radial wire inside the bottom of the boat.

21.0 TECHNICAL REFERENCE

The following chapter is intended for more advanced users who would like a better technical understanding of the complexities of the SG-2000 radio.

21.1 Squelch Scale Recalibration

The following procedure recalibrates the squelch level on the SG-2000:

1. Press: **Shift/Func** , **3 - Squelch Level -** , **0** Allow to time out.
2. Press: **Shift/Func** , **3 - Squelch Level -** , **9** Allow to time out.

This process recalibrates the squelch scale.

3. Press: **Shift/Func** , **3 - Squelch Level -** , **2**

This sets the squelch level to "2".

4. Activate or disarm squelch when operating by pressing: **3 - SQL**

21.2 SG-2000 MicroProcessor Reset Procedure

SGC recommends that the following procedure not be undertaken by inexperienced operators. This procedure involves identifying specific pins on integrated circuit chips. If you are not comfortable working at this level of detail on your SG-2000, please do not proceed. Return the radio to SGC or your SGC dealer for service.

To RESET the MicroProcessor in your SG-2000, follow the instructions below:

1. Turn off radio.
2. Remove Top Cover.
3. Remove MicroProcessor shield located at the right rear of exciter board when facing the radio. Refer to drawing (J40100930-B) in schematics and parts layout portion of this manual which follows the technical section. Identify clock chip IC-7 and pins 18 and 22 as shown in the following diagram:

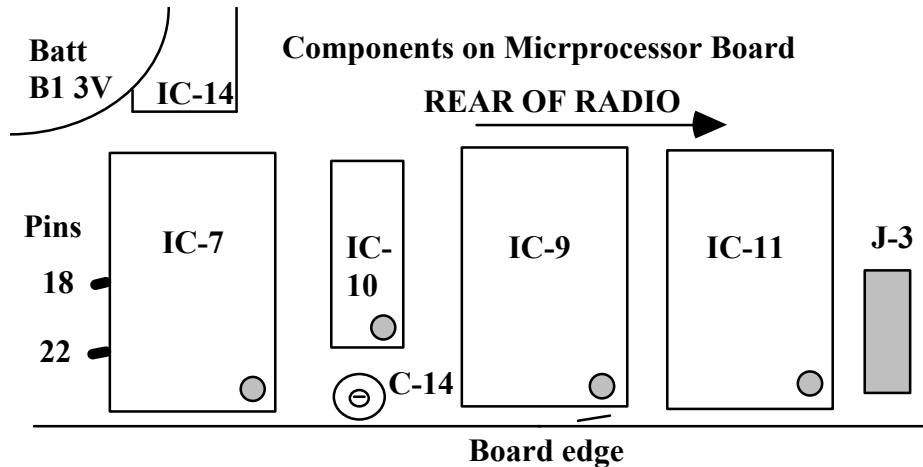

4. With power removed from the radio, momentarily ground pins 18 and 22 of IC-7 to chassis for 5 seconds each pin. Repeat.
5. Re-install MicroProcessor shield.
6. Re-install Top Cover.
7. Reapply 12 VDC Power and test.

Please call SGC if further assistance is required.

21.3 Emergency Calling

Alarm Start

There are two buttons which are bordered by a red outline on the front panel. One of these buttons is green and is labeled SHIFT/FUNC. The other is Red and is labeled EMER 2182. Pressing both of these buttons at the same time will begin transmitting an emergency beacon on whatever frequency is displayed. To send a beacon on the international distress frequency, 2182 KHz, press EMER 2182 alone first, then the two buttons together.

Once the alarm is started, it is only necessary to press the STOP button in order stop sending the alarm. The alarm will turn off after 45 seconds to allow you to hear stations which are calling to offer assistance in your emergency.

As a safety feature, the emergency beacon buttons may be engaged only by depressing both the EMER and Shift buttons simultaneously. This key stroke combination will instruct the Alarm Generator to begin an automatic transmit. For 45 seconds, two alternating tones will be sent by the SG-2000. These tones are recognized by the international shipping community as an emergency distress call. In some areas, automatic equipment can determine the location of the sending unit. The emergency transmission can be aborted by



depressing the EMER (STOP) button.

21.4 Basic Tune-up Procedure (Alignment)

- 1) Attach a wattmeter and a 50 ohm load to the antenna connector. Allow 10 minutes warm-up before proceeding.
- 2) Set radio to a channel in the middle of its operating range. Current production radios are aligned using ITU channel 1601.
- 3) Confirm that radio is in high power mode by observing the front panel LCD.
- 4) Attach accurately calibrated frequency counter to pin 14 of IC608 and Ground. Adjust the trimmer capacitors C639 and C640 to achieve 11.94 MHz +/- 1Hz.
- 5) Adjust R41 and R42 on the LPA to maximum output power (fully clockwise).
- 6) Set unit to CW mode. Key unit and adjust R119 on the exciter for 200 watt output power.
- 7) Readjust R42 to 150 W.
- 8) Readjust R41 to 50 W.
- 9) Change the channel to emergency frequency 2182 and set the mode to A3H.
- 10) Adjust R338 on the exciter for a carrier level between -3 and -6 dB, (37.5 to 75 watts).
- 11) Change the operating channel to channel 851 and set the unit to A3A mode.
- 12) Key unit and adjust R337 on the exciter for a carrier level of -16 dB +/- 2 dB, (2.3 to 6 watts).

Note: Bird wattmeter reads 40.5% on two tone test.

21.5 AM Filter Bypass

The SG-2000's normal range is from 1.6 to 30 MHz. To receive down into the AM band, you will need to bypass the AM filter. To do this:

1. Remove top cover by removing six 6-32 black Phillips head screws that secure the cover to the SG-2000.
2. Place radio with exciter PCB facing up.
3. There is a long "L" shaped metal heatsink bracket located on the left side of the exciter. On this bracket is the AM Filter PCB.
4. On the AM Filter board, disconnect the gray coax cable going to the RF-in jack and disconnect the short coax on the AM Filter into J101 on the exciter PCB. Tape up the short coax connector or remove the AM Filter board entirely.
5. Connect the long coax directly into J101 on the exciter PCB.
6. Replace the top cover and secure with the six Phillips head screws.

Your SG-2000 will now receive down to 500 KHz.

21.6 Oscillator and Filter Operation

(refer to block diagram J40100920)

Following is a list of the six major modules and their descriptive functions:

- (a) Microprocessor assembly
- (b) 11.94 Master oscillator with oven
- (c) VCOs
- (d) PLLs
- (e) Serial Logic Switches
- (f) Tone generator

Refer to Schematic Section at the end of this document.

(1). Microprocessor Assembly: This module can be broken down to four different parts;

- 1) MicroProcessor
- 2) RAM
- 3) ROM
- 4) Communication port

This module is responsible for programming the VCO and to control the tone frequencies generated.

(1) 11.94 MHz Master oscillator with oven: This module generates the reference frequency for all transmit and receive functions. The Oscillator must be set for ± 1 Hz at the highest operating frequency.

(2) VCOs: The VCOs produce the required frequencies to modulate and mix the audio signal in the unit. There are three VCOs in the unit to produce two IF frequencies in the radio.

(3) PLLs: The PLLs work in conjunction with the MicroProcessor to produce the required voltages used in the VCOs. There are four PLLs in the radio, three for the VCOs and one for the tone generator.

(4) Serial Logic Switches: These logic switches interface the to analog controls throughout the radio. They control the receive and transmit voltages, the output filters, and high/low power control.

(5) Tone Generator: The tone generator is a serial programmable divider controlled by the MicroProcessor to produce an audio frequency based on the reference clock.

21.7 MicroProcessor Assembly (*Schematic J30100930*)

This board is the primary controller for all functions of the SG-2000. The frequency and mode information is sent by the controller head processor to the radio processor. The radio processor then takes this information and converts it to digital signals used by the VCOs and other function switches. The digital control signal is sent out serially through the communication port on the MicroProcessor board to serially programmable devices on the exciter and the LPA. The signals control the VCO frequencies, the receive and transmit control voltages, carrier insertion levels, high and low power settings, tone frequency, and audio filter select.

21.8 VCO's (*Schematic J30100920*)

The VCOs (Voltage Control Oscillators) take an analog input voltage and produce a corresponding frequency depending on the LC resonance of the circuit. In VCO #1, one of the two inductors, L401 or L402 is switched in via D401 or D402 to oscillate with the series capacitance of VD401 and VD402. The series capacitance depends on the potential applied to the diodes VD401 and VD402. The oscillator is then amplified and buffered for the output. The same principle applies to VCO #2 where the determinate factors for the frequency are the capacitance of VD403 and L410. VCO #3 uses a 10.7 MHz crystal to produce the required frequency. The crystal is "pulled" up or down depending on the capacitance of VD404.

21.9 PLL's (*Schematic J30100920*)

The PLL (*Phase Lock Loop*) circuits take the reference frequency, 11.94 MHz, and the VCO output frequency and divides each one by a number determined by the microprocessor assembly. The circuit then determines the phase difference between the two results and outputs a high or low voltage, (0 or 8 volts) depending on the angle of phase difference. The voltage is then filtered and sent to the corresponding VCO. When the VCOs are locked, or in other words, when the two divided frequencies are the same and there is no phase difference, then pin 7 is set too high. The unit will not transmit unless all the PLLs are locked on the required frequency. One of the four PLLs is used in the tone generation, and does not require an output frequency feedback. (*See Tone Generator.*)

21.10 Serial Logic Switches (*Schematic J30100500*)

These serially loaded switches are contained in IC3 and IC4 on the LPA. The microprocessor sends a serial 16 bit word out along the data line while CS4 is held low. The 16 bit word is then latched into the two ICs and reflected on the output as either an open or closed collector. These high or low impedances control all the relays, High / Low power setting, high temperature protection circuitry, and the receive and transmit control voltages. The control voltages are used in determining the direction of IF frequencies and filters on the exciter and to enable RF power output.

21.11 Tone Generator (*Schematic J30100920*)

The tone generator is a PLL used strictly as a programmable divider. The PLL takes the reference frequency 11.94 MHz and divides it down to a frequency that can be used to produce an audio tone. Since there is a divide-by-4 circuit after the PLL, the microprocessor assembly must take this into account. *For example:* for a desired tone of 1000 Hz, the microprocessor programs the PLL with the following result; $11940000/4/1000=2985$

This would also mean that any deviation by the reference oscillator will be reflected in the tone by a 4000 to 1 ratio. For a 3 Hz deviation on the reference clock, there would only be a .0075 Hz deviation on the tone output.

21.12 Oven Switch On the back of the unit is a switch labelled **BAT-SW**. If there is power to the radio, this switch is used to select whether the power to the oven unit is supplied continuously (**BAT**) or only comes on when the SG-2000 itself is turned on (**SW**). Selecting either option depends on the operator's situation. Selecting **BAT** will keep the oven at the proper temperature even when the radio is off and enable immediate transmission upon turning on the radio; however, it will put a very small drain on your power source. Selecting the **SW** position will eliminate this drain but you will need to let the SG-2000 warm up for 10 minutes after turning it on before you can transmit. SGC recommends that if you are operating a fixed station on AC power, use the **BAT** position; if you are operating a mobile or marine station powered by a battery and go long periods between using the radio, select the **SW** position.

21.13 Alarm Generator

The alarm generator is for emergency use only and is activated by pressing two keys on the front panel. It generates two tones at 1300 and 2200 Hz using the tone generator mentioned above. The individual tone durations are intervals of 250 mS, and alternate for 45 seconds. The 250 mS time intervals are measured internally by the microprocessor clock. The 45 second alarm time is generated by a calender clock used in keeping track of the date and present time.

21.14 Master Oscillator with Oven

(Schematic J30100920)

The master oscillator is a self-contained crystal / FET 11.94 MHz oscillator within a tightly controlled oven operating at 65°C. The oscillator produces a 4Vpp sine wave signal at a frequency of 11.94 MHz \pm 3.4 Hz over a temperature range of -30 degrees C to +50 degrees C. The oscillator is coupled to the PLL chip IC610 and is buffered to pin 14 of that chip. The master oscillator is used as a reference for all the VCOs to establish the required frequencies determined by the micro-processor assembly. The oscillator is limited to a deviation of 3.4 Hz due to the division scheme utilized in the VCOs to correspond to a maximum deviation of \pm 10 Hz on the output of the unit in transmit and on the highest operating marine frequency band of 25 MHz.

21.15 Crystal Oven (Schematic J30100920)

The 11.94 MHz reference oscillator is maintained at a constant temperature by a solid state regulated oven. The temperature regulating circuit includes a power transistor (Q601) and a temperature sensing thermistor. On a cold start, the control transistor is full on and a maximum current of approximately 300 milli-amperes flows. When the equilibrium temperature is reached, the current drops to a low level just sufficient to maintain the set temperature.

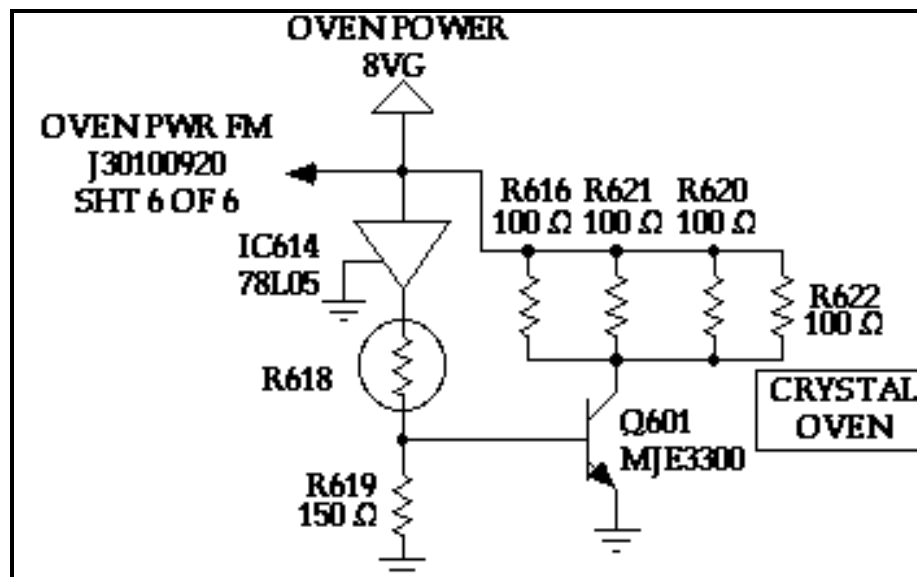

The complete oven assembly is enclosed in a thermal cover which retains the heat, reducing the amount of power required and providing more precise control of the oven temperature.

21.16 Output Low Pass Filters(Schematic J30100500 2/2)

One of six low pass filters located on the LPA assembly is selected by the MicroProcessor program. These filters eliminate harmonic distortion products from the linear power amplifier output signal.

The following table lists the upper cut-off frequencies of the six bandpass filters selected in the LPA.

2.9MHz
4.6MHz
9.0MHz
15.6MHz
20.7MHz
30.0MHz

21.17 Automatic Level Control (Schematic J30100500) 2/2

Following the low pass filter, the forward power is sampled by a peak detector consisting mainly of the transformer T14 and the diode D18. A DC signal proportional to the forward power appears at the node of R71/C103; the reverse power appears at R69/C99. The forward DC representative is then amplified by IC2A and given a release time constant defined by C68 and R79. This is then fed to a summing device used to control the level going to the AGC. The AGC in turn controls the audio level going to the modulator (IC202) to maintain output power level of 150 watts.

21.18 Modulation Characteristics, Audio Frequency Response

In order to test the modulation characteristics, a single tone, variable frequency signal was applied to the microphone input of the transceiver. The ALC circuitry was disabled. The RF output of the transmitter as a function of the audio frequency was measured and plotted. Results are shown graphically below. Audio frequency was varied over the range of 100 Hz to 5000 Hz.

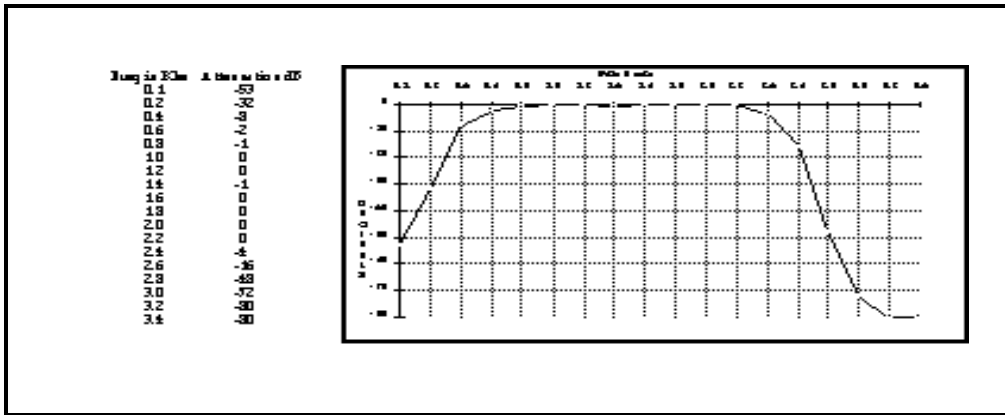

21.19 Modulation Characteristics, Peak Envelope Power Limiting

In order to test the modulation characteristics, a two-tone audio signal was applied to the microphone input of the transceiver. Frequencies of the tones were 400 Hz and 1800 Hz. Amplitude of the composite audio signal was adjusted to ± 10 dB above the level required for full power output (*150 watt PEP*). The relative level of the two audio tones was set such that the two principal RF frequency components of the RF output were equal in magnitude.

The ALC control; R162 - shown in drawing (*Schematic J30100500 2/2*) was adjusted to limit the power output to 150 watts.

Note that the modulation limiting circuit includes a peak detector thereby performing the identical function for A3A, A3J and A3H modulation.

INPUT LEVEL 0 Db =300mV

Power output in Watts

INPUT dB	A3J Watts	A3H Watts	A3A Watts
-50	0.0	37.0	3.9
-40	0.2	38.7	4.5
-30	1.6	50.0	8.0
-20	18.0	103.7	37.0
-10	131.2	144.5	144.5
0	141.1	147.9	147.9
10	147.9	147.9	147.9
20	147.9	147.9	147.9

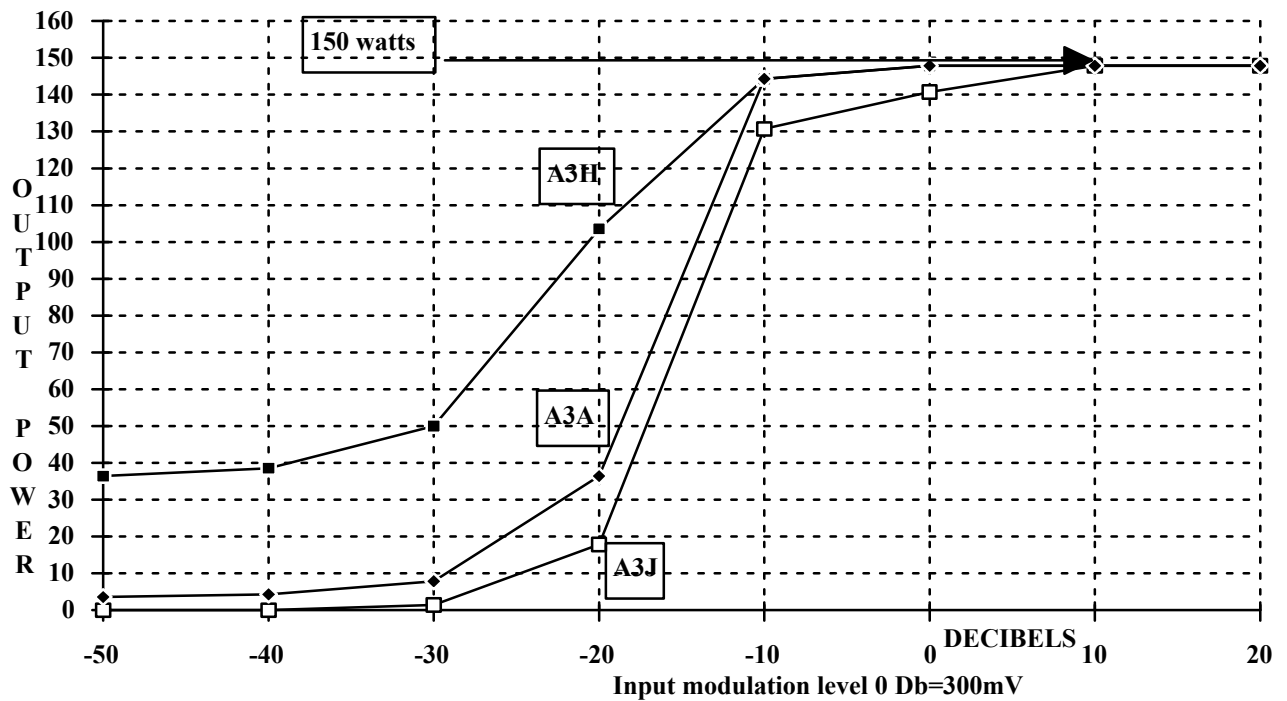

21.20 SG-2000 Performance Measurements

The following is a diagram of how to set up appropriate test equipment to ascertain the performance of the SG-2000 transceiver.

It is important that the equipment be set up as noted in the diagram on the following page and that the technician or engineer performing the measurements insures that all test equipment is in good working order and has been properly calibrated prior to performing measures.

The SG-2000 is completely aligned and tested at the SGC factory prior to shipment. No further adjustment of the radio should be necessary. It is recommended that the operating frequency of the radio be certified by a qualified technician on an annual basis in conjunction with a good preventative maintenance program as noted earlier in this manual.

EQUIPMENT LIST FOR TRANSMITTER TEST:

Instrument	Manufacturer	Model	
Tracking Generator	Hewlett Packard	HP8443A	
Spectrum Analyzer	Hewlett Packard	HP88538B	(RF)
		HP88538B	(IF)
		HP141T	(Display)
Audio Generator (2)	Hewlett Packard	HP204D	
Oscilloscope	Tektronix	5403	
Wattmeter	Bird	43	
Dummy Load	Bird	8327	
Attenuator	Microlab	N/A	
RF Voltmeter	Hewlett Packard	HP410C	
Temperature Chamber		Assoc. Test Labs	RD1300
VOM		Simpson	260
DC Power Supply	Sorenson	SRL60-35	
Digital Voltmeter	Hewlett Packard	970A	
RF probe	Hewlett Packard	N/A	
Frequency counter	Hewlett Packard	5381A	
Time base standard	Hewlett Packard	H40-107BR	

TEST EQUIPMENT SET-UP FOR SG-2000

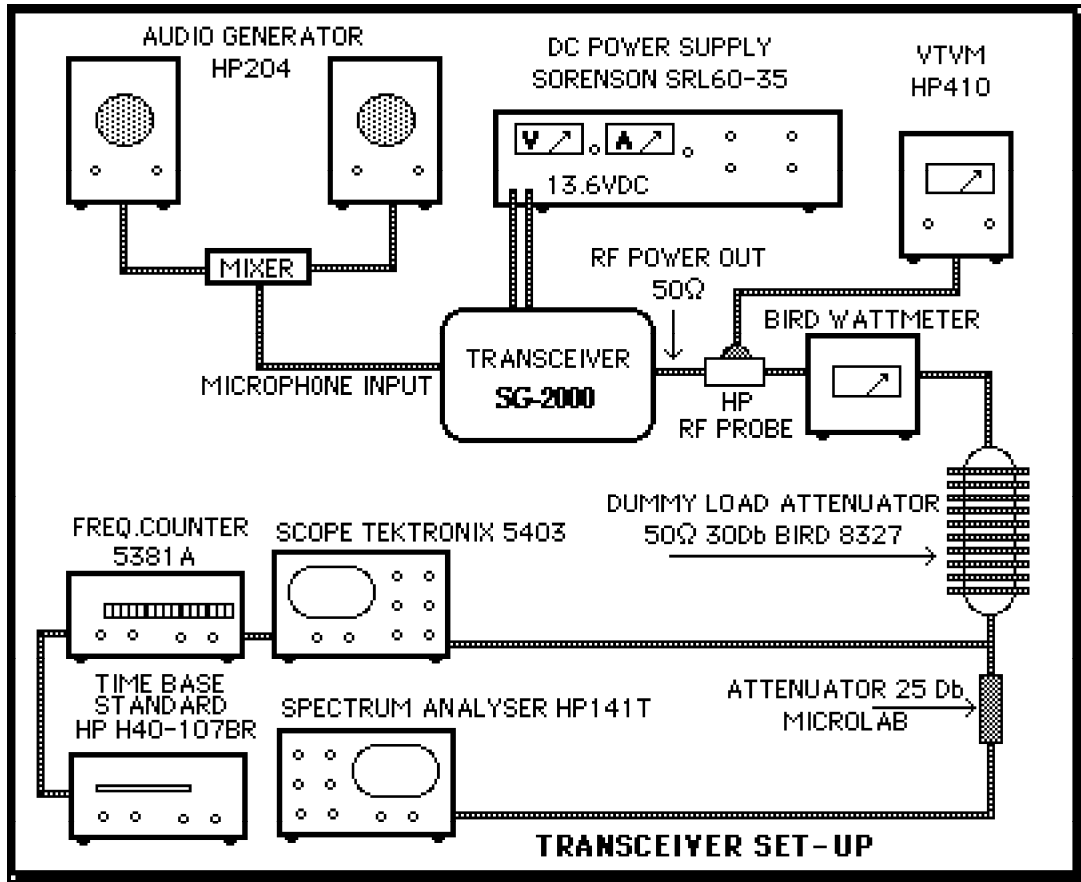



Internal cable from main radio unit to local control head

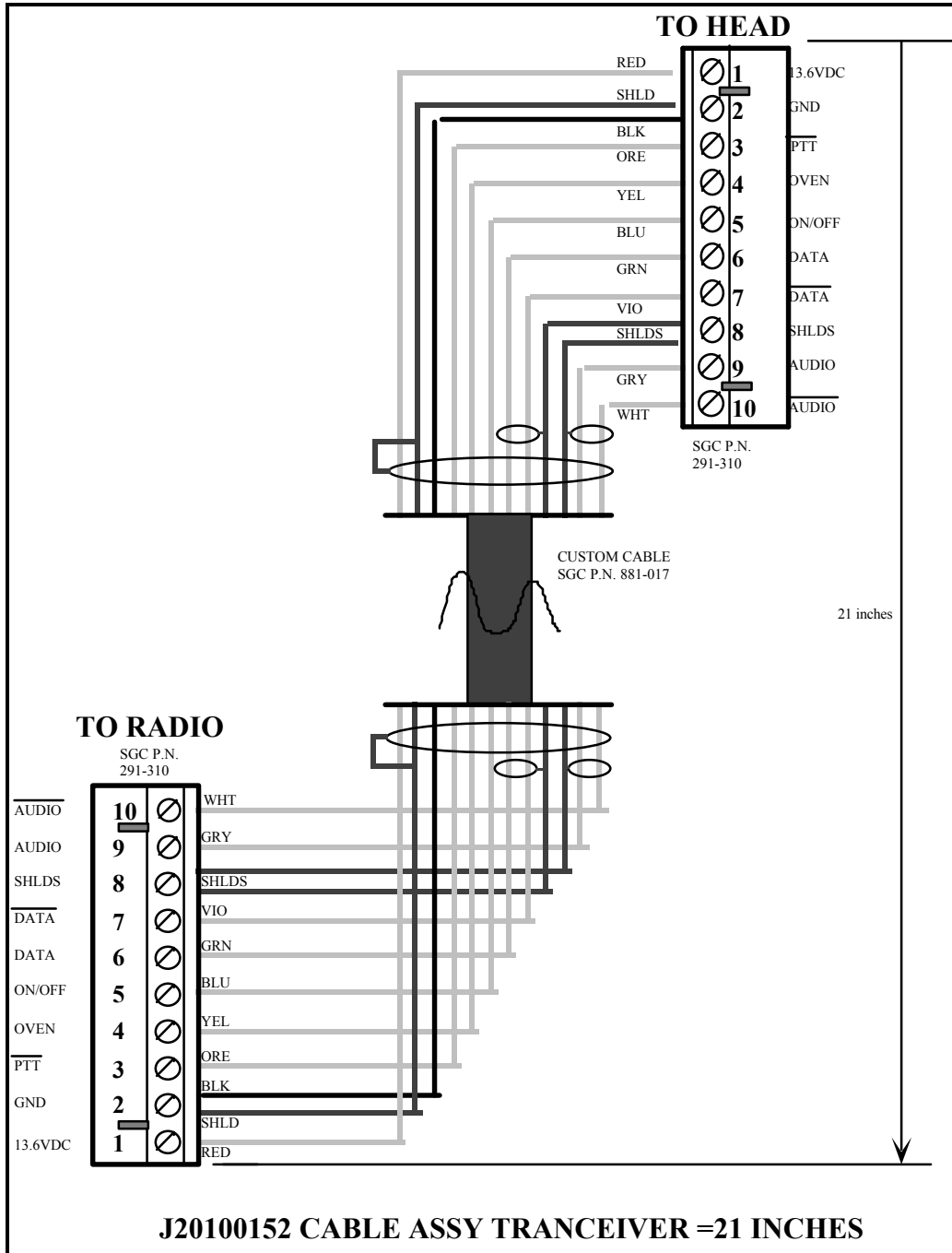

External cable from main radio unit to remote control head

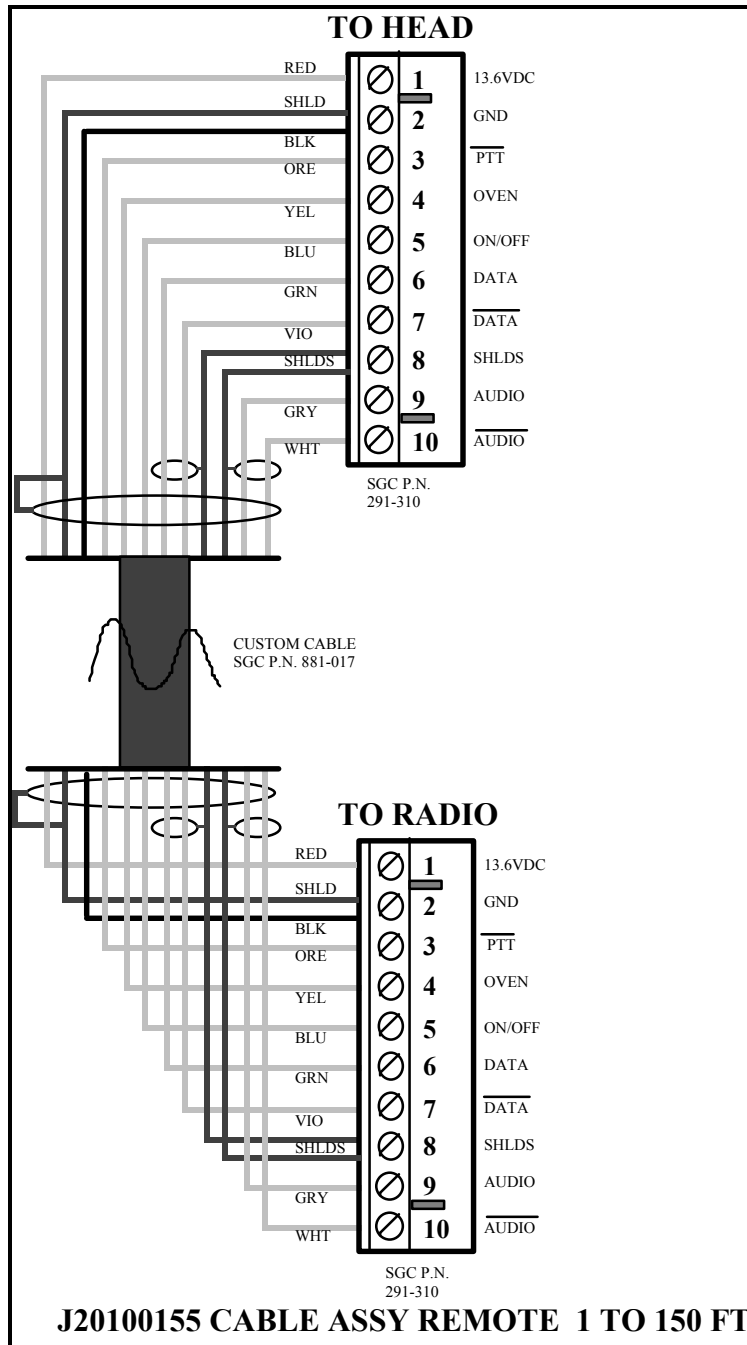

Internal ribbon cable for communication of the Exciter board to Linear Power Amplifier board

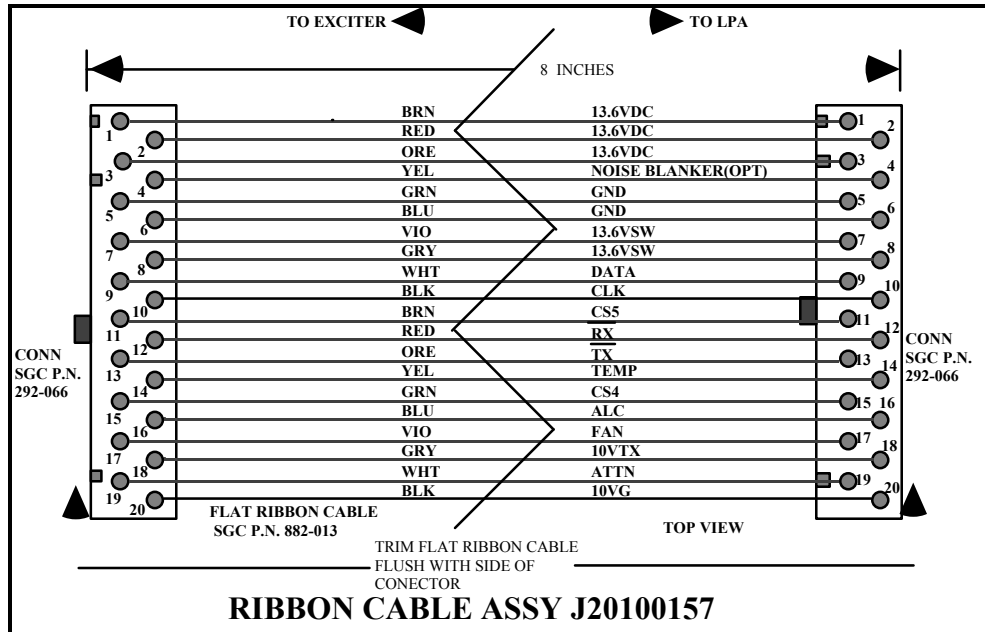

Total length 8 inches

Speaker assembly and connection

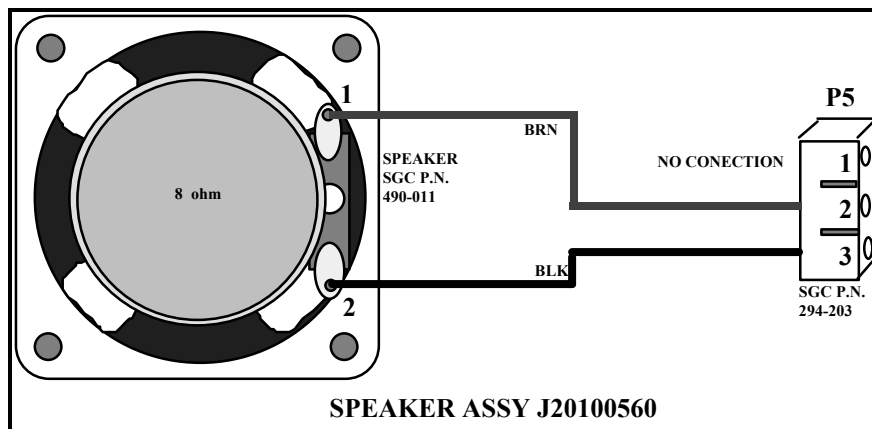

Front panel microphone connector assembly and connection

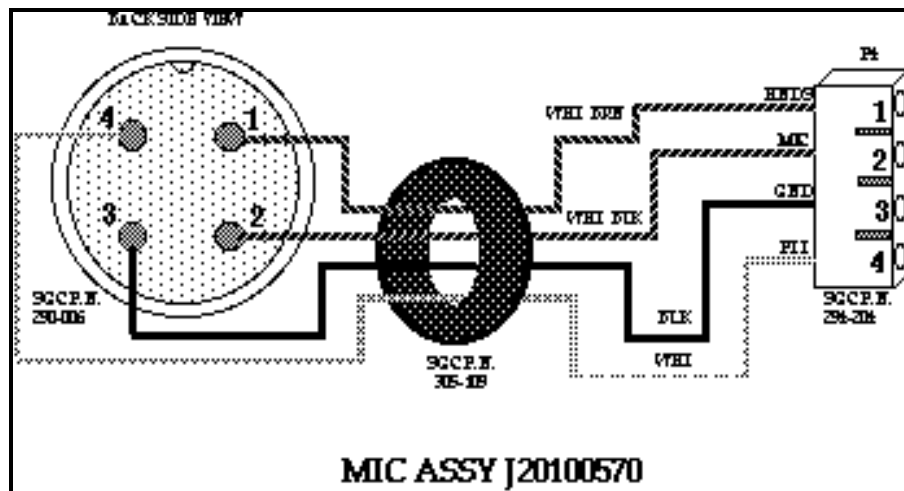

22.0 Trouble Shooting

22.1 Dysfunctions

1. In the event you experience a failure of either output section of the LPA (Linear Power Amplifier), it is probable that the output combiner transistor (R-21) will also fail and need replacement to restore proper operation.
2. Over/Under voltage protection is included in the SG-2000. In the event the unit fails to operate, and you believe power is supplied, but the STBY (standby) light is not lit, please measure the power supply for proper voltage and polarity.
3. If you are operating and the TEMP light comes on after extended voice operation, insure that the antenna system which is used is presenting a reasonable load to the radio. The SG-2000 is normalized at 50 ohms and will operate satisfactorily up to 2:1 SWR levels. Beyond this, power output is reduced and the radio runs hotter, increasing the likelihood that a TEMP light will come on.
4. If you hear no audio coming out of the speaker of the SG-2000 make sure that SQL is off and that the SPK (speaker) is indicated on the front panel. Remember the external speaker jack on the rear panel of the SG-2000 is active only if the radio has a control head attached to the body of the radio.
 - If you are wondering if the SG-2000 is working in the receive mode, remember that you can usually hear traffic by tuning across the bands. We suggest you listen to WWV, the international time and frequency standard which broadcasts 24 hours a day on 5, 10, 15, and 20 MHz. You should be able to receive this station on one or more frequencies at all times.
 - If you are using the SG-2000 with the SG-230 Smarttuner, remember that the Smarttuner will only pass signals near the band the coupler is being used on, unless you have selected Jumper J-2 on the SG-230 to the "Yes" option, which bypasses all active tuning elements in the receive mode or the coupler has been reset by interrupting power momentarily.
5. If you are not answered by stations in the CW mode, remember the tone of the station you are listening to must be the same as the sidetone of the SG-2000 BEFORE USE OF CLARIFIER. Make tone adjustments using clarifier AFTER you have set your transmit

frequency on the station you wish to work.

22.2 Scanning in One Direction Only

SGC has received several technical support calls inquiring about the radio scanning only in a single direction. In these cases, the radio is reported to be scanning in only one direction toward a certain frequency. If the radio is set to a low frequency, it may only scan upward toward a higher frequency. At high frequencies, the unit may only scan toward a lower frequency.

This is not a defect with your radio. This indicates that a frequency has been inadvertently entered in the programmed scan frequency provision of the radio. See Programmed Scan in the "Scanning" section of this manual for complete details.

As you may be aware, you may enter two frequencies and have the SG-2000 scan between them. These are designated "LC" and "UC" on the left hand side of the LCD display. To remove the frequency scan brackets and restore the radio to scanning in both directions, proceed as follows:

1. Depress "PRGM", "SCAN", "CHAN" buttons.
2. You will see the following: LC: - - - - on the radio display if the lower scan bracket is empty.
3. You may see the following: LC: - - 21 if channel 21 (for example) has been entered as the lower scanning bracket.
4. To delete LC: - - 21 (Or any other channel displayed) depress "SHIFT" "7" (DEL)
5. Depress the "CHAN" button again and the radio will display: UC: - - - - if the bracket is empty.
6. If you see UC: - - 42, this means channel 42 (for example) has been entered as the upper scanning bracket.
7. To delete UC: - - 42 (or any other channel displayed) depress "SHIFT" "7" (DEL)
8. A hidden frequency may have also been stored* in either the LC or UC bracket. To remove it, you must locate it, program that frequency into a channel, then delete that channel.

Note: The hidden frequency scan provisions are not a documented feature and are not accessible in civilian versions of the SG-2000.

23.0 SG-2000 Factory Test Procedures

This section details the bench tests the SG-2000 goes through before it is shipped out to the customer. It is included here for our more electronically-minded customers who might want to do their own troubleshooting at the board level. It is highly recommended, however, that any SG-2000 with board-level problems be sent back to SGC Inc or to an authorized dealer for repair.

For testing purposes the SG-2000 is broken down to four subassemblies: Exciter, LPA, Head and Main CPU (treated as one), and the Display subassembly.

23.1 Exciter Testing Procedures This section contains the required documentation for testing and trouble-shooting the Exciter subassembly.

23.1.1 Required Testing Equipment

S/N Meter
Frequency Counter
RF in line voltmeter
RF Signal Generator
Audio Signal Generator
Power Supply Capable of at 35 Amps at 13.6 Volts
Connection Extension Cables
Exciter-LPA ribbon cable
CPU-Exciter ribbon cable
Spectrum Analyzer
Sweep Generator
Digital Multimeter
SG-2000 Head
SG-2000 Chassis with LPA
SG-2000 Main CPU
Oscilloscope
Bird RF thru-line power meter with 250 W slug capable of reading in the 1.6-30 MHz range.

23.1.2 Circuit Description

The Voltage Controlled Oscillator.(VCO sections are composed of a programmable Phase Lock Loop (PLL) and an oscillator section. (Sheet 6 of 6 of drawing J30100920 is the PLL section.) The processor board communicates with this area to program frequencies for mixing. The communications link between the processor board and the PLL is on sheet 5 of 6. Sheet 5 of 6 shows

mainly drivers and a multiplexer (IC510) for addressing each VCO. The oscillators are on sheet 4 of 6 and each has an input tuning voltage range between 0 and 8 volts. As the voltage increases, the capacitance on the varicaps goes down, thus increasing the oscillator frequency. The PLLs control this voltage by doing a comparison between a division of the reference oscillator and the output frequency.

The receiver section of the radio involves three LOs to create two IF frequencies. Starting on sheet 1 of 6, drawing J30100920, the signal comes in via J101 from the Linear Power Amplifier (LPA), then through a switchable 20 dB pad, then through the 10 dB amplifier made with IC103 and then through a 30 MHz low pass filter to the first mixer. The mixer flips the frequency up to an IF frequency between 82 and 86 MHz. This frequency span is cycled through every 20 KHz of operating frequency due to the mixing scheme of the radio. The 82 MHz RF amplifier adds about 25 dB to the signal before going through the 82 MHz band pass filter. The 82 MHz filter is a very tight filter used in the IF stage to increase the selectivity of the receiver and to attenuate the LO signal coming through Mixer A102. It is then mixed down to 10.7 MHz.

Sheet 2 of 6 takes the signal and passes it through the side band filter or an optional filter depending on which mode or option the radio is configured for. The IF amplifier transfers the signal to the demodulator, IC202, to create the audio signal at TP204. The IF amplifier has a gain control on pin 5 which is a feedback from the AM detector on sheet 3 of 6. This is used to limit the signal level and prevent the demodulator from being over driven.

The audio signal is then filtered by either the voice filter or the telex filter depending on which mode of operation the radio is in. The signal is then routed to an Automatic Gain Control (AGC) circuit. The AGC circuit tries to maintain a certain audio level going into the input / output buffer on sheet 3 of 6. The receiving path is divided into two paths, one which is the 600 Ohm output buffer and the other is the balanced head audio output.

In general, the transmit path follows the receiver path backwards. The audio signal is brought in by either the back connector J301 or through the balanced audio input (J503 and J504) from the heads. The signal is then brought into the Automatic Level Control (ALC) circuit, IC208, on sheet 2 of 6 drawing J30100920 where the proper audio level is established and is sent to the modulator (IC202).

The audio is then modulated to 10.7 MHz and sent to the clipper circuit. The clipper circuit is used for compression of the audio signal on the RF level. This is done to produce a higher RMS power level and to produce a more intelligible signal when the signal is received on the other end. This signal is

then put through the USB filter to get rid of inter-modulation and the other sideband. Both upper and lower sidebands can be sent through this filter by changing the mixing schemes through out the radio with an offset equal to the USB filter bandwidth.

This signal is then bumped up to the IF frequency between 82 and 86 MHz (along with a re-injected 10.7 MHz for carrier for A3A and A3H modes only). The 82 MHz filter is used to attenuate the LO frequency and other miscellaneous signals outside its range. The signal is then amplified and mixed down to the RF frequency. A 30 MHz filter band-limits the signals going out before the transmit buffer increases the transmit level to the level needed to drive the LPA.

23.1.3 Test Setup

Make a visual inspection. Look for quality defects. Check all electrolytic capacitors, diodes, transistors, IC's, solder bridges, etc.

Use the multimeter in the Ohms position. Check for short circuits on the main and regulated power lines: 5VG, 8VG, 10VG, 10VRX, 10VTX, 13.6VSW and 13.6V unswitched.

Connect extender cable from J15 on the Test Chassis to J506 on the exciter board under test.

Connect extender cable from J1 on the Test Microprocessor board to J501 on the exciter board under test.

Plug SG-2000 Head into J503 or J504 connector.

Apply power to the exciter by pressing the "POWER" button on the Head and turn radio on.

Using the multimeter test each test point for the following voltages.

TP501	8VG
TP502	10VG
TP503	5VG
TP504	10VRX

Program the frequency 15.0 MHz into the head to verify if head displays data and there is interaction between radio and head. Refer to operating instructions for programming procedures.

23.1.4 11.94 MHz Reference Oscillator Test

The oscillator will drift for the first 10 minutes after power is applied while the surrounding oven warms up. Check for ~ 1.6 volts on R619 when the power is first turned on. (In the event of failure, refer to the crystal oscillator section of the schematic.)

Check TP604 (or pin 14 of IC610 on older boards) for 11.94 MHz, 6 ± 0.5 Vpp. Adjust capacitors C639 (fine) and C640 (coarse) for 11.94 MHz ± 2 Hz on the frequency counter. Note: do not adjust C639 and C640 if the radio has been on for less than 15 minutes.

Verify that the oscillator will work properly with SW501 oven switch in both positions.

23.1.5 VCO Checks**VCO 4, 10.7 Oscillator**

Set radio in USB and A3J mode. Check for 4.8 VDC to 5.1 VDC on L416.

Note that the 10.7 oscillator is disabled and there is no voltage on L416 only if the radio is in receiving A3H mode (in all other modes, Q409 will be biased).

Attach frequency counter to TP403 and the voltmeter to TP603. Adjust C447 for 5 volts ± 0.2 volts on the voltmeter. Frequency counter should read 10.7 MHz (USB).

Attach oscilloscope to TP403. Adjust T404 for the maximum level, approximately 1.4 Vpp volts on the oscilloscope.

In the event of failure, refer to the VCO troubleshooting section.

VCO 2, 72 - 76 MHz Oscillator Check

Set radio frequency to 29.9999 MHz.

Attach scope to TP402, it should read 2 ± 0.5 Vpp.

Attach voltmeter to TP602 and frequency counter to TP402, use a X1 probe on the frequency counter.

Adjust L410 for 5 ± 0.2 VDC.

Frequency on TP402 should be 75.60 MHz.

In the event of failure, see the VCO troubleshooting section.

Secure L410 on PCB with a few drops of polystyrene Q-dope.

VCO 1, 84-114 MHz Oscillator Check

Note: VCO1 covers 2 sub-bands: LO = 84.14 - 97.34 MHz,
HI = 97.34 - 112.34 MHz.

Attach scope to TP401.

Attach voltmeter to TP601 and frequency counter to TP401, use an X1 probe on the frequency counter.

High VCO Check

Set radio frequency to 29.9999 MHz. The scope should read 1 ± 0.5 Vpp.

Adjust L401 for 7.0 volts ± 0.2 VDC.

Set radio frequency to 16 MHz, the frequency counter should read 98.34 MHz.

Low VCO Check

Set radio frequency to 15 MHz, the counter should read 97.34 MHz and the scope should read 3 ± 0.5 Vpp.

Adjust L402 for 7.0 volts ± 0.2 volts on the voltmeter.

Secure L401 and L402 on PCB with a few drops of polystyrene Q-dope.

23.1.6 Receive Sensitivity Check

The following describes the alignment of the receiving path on the exciter, starting at RF In (J101) and finishing at pins 9 and 10 of J503/J504 where the audio signal is passed to the SG-2000 head.

82 MHz filter calibration description. See diagram below:

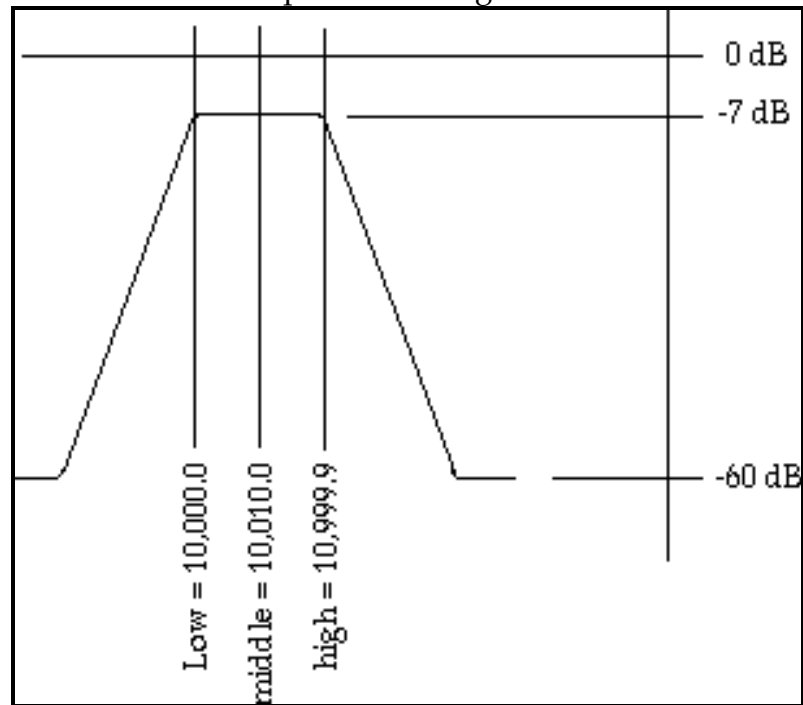

This is a combination of two filters: one band-pass filter composed of T106-T108 coupled with a High-pass filter composed of L121-L127. The left side edge of their graphed band pass coincide. The result is a band-pass filter with the limits at 82 MHz and 86 MHz. The 82 MHz filter will be adjusted for a flat response in the band 82-86 MHz by:

- 1) comparing within 1.5 dB the sensitivity measured at J301 RX Out for three specific RF frequencies. These frequencies correspond with the positions of low, middle, and high on the graphed band-pass characteristic of the 82 MHz filter.
- 2) connect the Spectrum Analyzer on points A and B at the ends of the 82 MHz filter noted on the schematic, with the radio turned OFF. The filter will be swept and should be adjusted as follows:

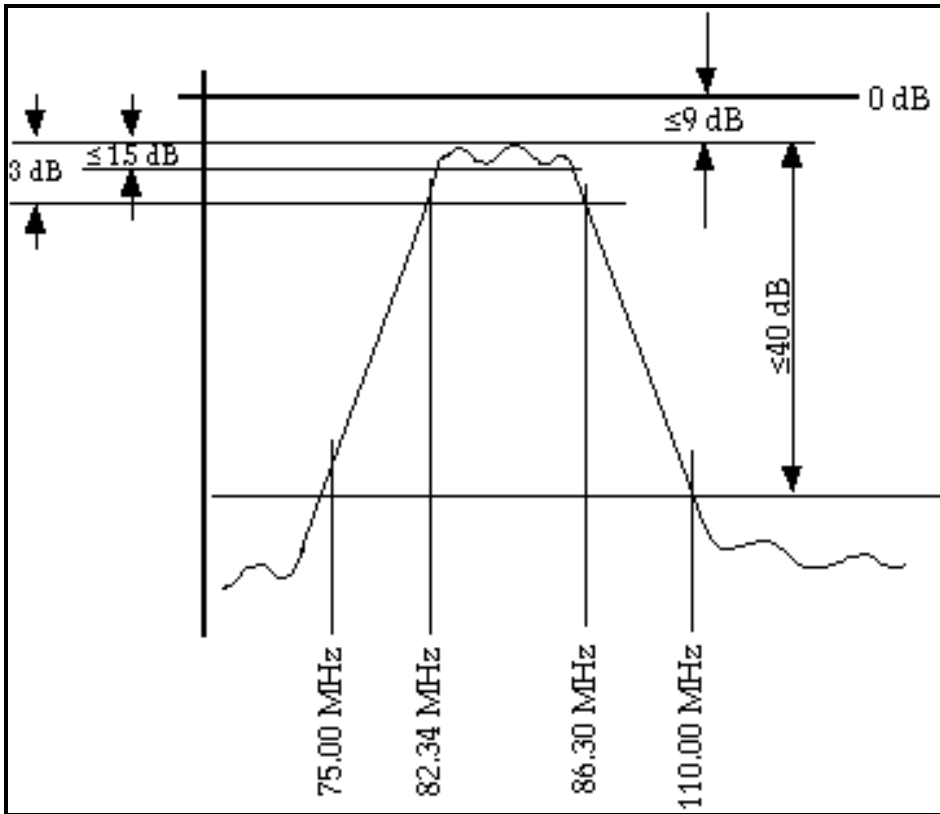

23.1.7 82 MHz and Displayed Frequencies Relationship

Note: This test will show the band position of the 82 MHz filter used by the first intermediate frequency. It is not intended as a routine testing procedure but could help in troubleshooting

Connect the Spectrum Analyzer to the second mixer, pin 8 (VCO 2 input)

Check for the following values:

Displayed Frequency	VCO2 Frequency	+10.7	82 MHz Filter	
			Lo End	Hi End
10,000.0 KHz	71.64 MHz	82.34	82,340.0 KHz	86,300.0 KHz
10,019.9 KHz	75.60 MHz	86.30		

23.1.8 SSB Alignment

See setup test schematic.

Reduce the AGC response to a minimum by turning R286 fully clockwise.

Inject at SG-2000 RF In/Out 10 μ V (or less if the audio out on J103 looks distorted) of 10,001.0 KHz.

Turn the radio on and program in the frequency 10,000.0 KHz A3J, USB, VOC, SPK modes. You should be able to hear the 1 KHz tone difference between the two frequencies and read it on the oscilloscope. If not, refer to the troubleshooting section.

Adjust T404 for 200 mVpp on IC202 pin 10.

Monitor the dB-meter attached at J301 and maximize the signal by adjusting R238, T202, T201, T105, C160, T106, T107, T108 and L121 to L127. Pass through the tuning of the 82 MHz filter a few times to obtain the maximum signal strength. Reduce the RF In to .5 μ V and note the dB level at J301.

Switch SW1 to GND position and note the dB level at J301. It should read -20 to -25 dB (.08-.05 VRMS). The difference between the .5 μ V RF In reading and no RF In reading should be =15 dB. If not, repeat steps above or refer to the troubleshooting section.

Turn the power supply off

Solder the surrounding shield on the 82 MHz filter with a bead of solder all around. Note: keep the top shield positioned on top of the surrounding shield for better positioning of holes, but do not solder together the two shields yet.

Change RF In to 11,000.9 KHz and the radio to 10,999.9 KHz. You should be able to hear and monitor on the dB meter and scope the 1 KHz tone difference.

Adjust T106, T107 and T108 for maximum indication on the dB-meter. Note the dB level and compare it with the level read at 10,000.0 KHz. It should be within 1.5 dB difference.

Repeat the two steps above for 10,011.0 KHz on the RF Generator and 10,010.0 KHz on the radio.

If the three dB readings from 10,000.0 KHz, 10,010.0 KHz and 10,999.9 KHz are not within 1.5 dB difference, and the S/N ratio is not =15 dB (>10 dB for Rev E boards and earlier), repeat this procedure or refer to the troubleshooting section.

Change modes to A3A, CW, A3J. There should not be any difference in the

receiving quality.

Note: the next steps are not necessary if all previous steps were successful.

Fine tune the 82 MHz filter using a Spectrum Analyzer (see 82 MHz filter calibration described above).

Turn the power supply to the radio OFF.

Connect RF output of the Tracking Generator to point A on the Exciter with 0 dB output 84.00 MHz.

Connect RF input of the Spectrum Analyzer to point B on the Exciter with the attenuator set to 20 dB, scan width = 2 MHz per division, 10 dB Log scale, scan mode = internal, scan trigger = Auto.

Adjust C160, T106, T107, T108 and L121-L127 to obtain on the Analyzer a graph shape similar to the second graph described in the 82 MHz filter calibration section above.

In the event of failure, check for shorts and bad components

23.1.9 AM Mode Alignment

Note: This step should be done after successfully aligning the radio in SSB mode

Set radio to 10,009.0 KHz, A3J, USB, ATT off, Speaker on, VOC filter in and minimum AGC.

Attach Oscilloscope and dB meter to RX Out on J301 (sheet 3 of 6).

See test setup schematic.

Apply a 0.5 μ V, 10,010.0 KHz signal to the RCV In on J101 (see test setup configuration). Check for 1 KHz signal on the oscilloscope and verify that the S/N ratio is 15 \pm 5 dB.

Change the radio to 10,010.0 KHz, A3H mode. Make sure jumper on J507 is in the AM position.

Change RF input to AM with about 50% modulation of a 1000 Hz tone. Increase the output of the generator by 5 dB.

Adjust T301 and T302 in the AM filter and T202 for maximum audio output of the modulating tone. Repeat the above step to reach a S/N ratio = 10 dB.



Decrease the RF In to .5 μ V and verify that S/N in A3J did not change.

In the event of failure, refer to the Receive Troubleshooting section.

23.1.10 20 dB Attenuator Check

A 20 dB Attenuator is selectable in receive mode by pressing the 20 dB ATTEN key, and is enabled automatically when in transmit mode.

RX: To check the attenuator in receive mode, set the radio to 10,000.0 KHz, A3J, USB, VOC, SPK, with AGC at minimum and RF generator to 10,001.0 KHz, .5 μ V connected at SG-2000 RF In/Out. Note the audio level on the dB meter attached to J301 Audio Out.

Engage the Attenuator on the radio and note the indication of the dB meter. The attenuator should produce a 20 \pm 2 dB attenuation of the audio signal at J301 Audio Out

TX: To check the attenuator in transmit mode, turn the attenuator off and replace the RF generator with the dummy load.

Change mode of transmit on radio to A3J.

Monitor IC101 pin 1 with a voltmeter.

Key the radio in transmit. The voltage on IC101 pin 1 should change from < .5 VDC to 10 VDC, indicating that the Attenuator is engaged automatically while in transmit.

23.1.11 AGC Adjustment Turn the radio on and program the frequency to 10,000.0 KHz A3J USB VOC SPK.

Apply .5 μ V 10,001.0 KHz at the RF In.

Attach the scope and dB meter to J301 Audio Out. You should be able to hear on the speaker and monitor on the dB meter and scope a 1 KHz tone.

Adjust R286 to approximately half value and note the value of the dB meter reading.

Increase the RF In signal by 90 dB (32 mV RMS) and note the value of the dB meter reading. The increase of Audio Out should not be more than 5 dB and the scope signal should increase without distortion.

In the event of failure, refer to the Receive troubleshooting section.

23.1.12 600 ? Port/Audio Out Check

Set RF Generator to .5 μ V 10,001.0 KHz

Set the receiver to 10,000.0 KHz, A3J, VOC, USB. A 1 KHz sinusoidal tone should be heard on the speaker and monitored on the scope.

The following values should be read at J103 pin 3 (Audio Out):

Setting	min AGC, R286 fully clockwise	mid-range AGC, R286 at mid value	max AGC, R286 fully counter- clockwise
Audio Out	2.5 \pm .5 Vpp	1.8 \pm .2 Vpp, no clipping	1.0 \pm .2 Vpp, no clipping

23.1.13 Head Port Audio Out

Set RF Generator to .5 μ V 10,001.0 KHz.

Set the receiver to 10,000.0 KHz, A3J, VOC, USB.

A tone should be heard and monitored on speaker and oscilloscope.

The following values should be read at J503 and J504, pins 9 and 10, with reference to GND:

Setting	min AGC (R286 fully clockwise)	mid-range AGC at R286 (R286 at mid-value)
Audio Out	1.5 \pm .2 Vpp	.5 \pm .1 Vpp

23.1.14 Voice/Telex Filters Check

Telex: Set the radio to 10,000.0 KHz, A3J, USB, SPK, TLX

Set RF Generator to 10,001.0 KHz.

Monitor the audio tone on the dB meter and frequency counter attached at J301 audio out and move the RF generator through the audio band until a maximum audio signal is found. This should be 1700 \pm 100 Hz, flat within 3 dB.

Voice: Change mode on the radio to VOC. The audio band-pass should be wider; 350 to 3200 Hz, flat within 3 dB.

23.1.15 Transmit Calibration

The following steps will adjust and verify that the RF out from the Exciter will drive the input of an SG-2000 LPA and produce 150 W (ALC disabled) into a dummy load. The audio signal used to produce RF Out from the Exciter can be selected between the 30 mV microphone input, CW tone generator on the Exciter or 600? audio generator attached at J301 Audio In. All sources should be adjusted for the same level at TP203 and produce the same Exciter RF Out.

Attach a 50 ? dummy load to J102 RF Out. Reduce ALC response to minimum by turning R41 and R42, on the LPA, fully clockwise.

Set R119 to mid setting and R121 to max value (fully counterclockwise).

Set the radio in receiving mode, A3J, USB, VOC, 10 MHz.

23.1.16 Microphone Level Adjustment

Inject 1 KHz, 30 mV RMS into the mic jack on the head.

Key the radio in transmit and verify with a scope the following levels:

- J504 pin 9 and 10 to GND: 1.5 Vpp, no distortion. Adjust R66 (microphone gain) inside the head if this value is different.
- Using the scope to monitor TP203, verify that the signal is 300 mVpp, for Rev F and earlier boards. For Rev H and later boards, adjust R316 to get 150 mVpp on TP203.

23.1.17 CW Level Adjustment

Note: The SG-2000 produces a J2E (A2J old denomination) type of CW transmission. This is done by substituting microphone signal from the head with a 1000 Hz tone in an A3J configuration. The tone is produced on the Exciter board and its level is adjusted by R610.

With the radio in receive, CW, USB, VOC and the Exciter RF Out connected to a 50? dummy load, key the radio in transmit and adjust R610 to 150 mVpp (300 mVpp for excitors of Rev F and earlier) at TP203.

Check for: TP301 = 240 ± 10 mVpp (for Rev H and later PCBs)

TP605 = 200 ± 10 mVpp (for Rev H and later PCBs)

23.1.18 600? Port Check

With the radio in A3J, USB, VOC and a 50? dummy load connected to the Exciter's RF Out, turn the radio power on.

Apply at J301 Audio In 195 \pm 10 mV RMS (500 mV RMS for Exciters Rev G and earlier) of 1000 Hz sinusoidal tone.

Key the radio in transmit and verify that the level at TP302 is 150 mVpp. This should correspond to :

$$TP301 = 240 \pm 10 \text{ Vpp}$$

$$J301 \text{ Audio In} = 240 \pm 10 \text{ mVpp.}$$

23.1.19 SSB Transmit Alignment

With the radio in 10 MHz, CW, USB, key the radio and verify a level of 150 mVpp (300 mVpp for Exciter boards of Rev G and earlier) on TP302. If a different level is shown, repeat Microphone and CW level adjustment.

Verify with the scope that the level at TP205 is 4.5 \pm .2 Vpp and adjust R238 to obtain a well balanced signal.

Attach scope probe to TP201 and adjust T203 for maximum signal.

Verify the following levels

	Rev H boards	Rev G and earlier boards
TP201 =	300 \pm 20 mVpp	600 \pm 20 mVpp
TP101 =	70 \pm 10 mVpp	100 \pm 10 mVpp
TP102 =	580 \pm 20 mVpp	1.1 \pm .1 Vpp
TP103	60 \pm 10 mVpp	100 \pm 10 mVpp

Adjust R121 to obtain a level of 2 Vpp on the collector pin of Q103. This should be able to be adjusted in the range of 30-60% of the R121 value.



23.1.20 Carrier Insertion Adjustment

Note: The SG-2000 produces A3A, A3H modes of transmit by inserting a 10.7 MHz carrier through the Base pin of Q102 at levels of -14 dB and -2.5 to -4.0 dB

Turn the radio on in Receive, 8.0 MHz, A3A, USB and have a 50 Ω dummy load connected to RF Out from the Exciter.

Key the radio in transmit and adjust R337 to get a value of 520 ± 20 mVpp on the Collector pin of Q103

Change the radio to 2.0 MHz, A3H, USB

Key the radio in transmit and adjust R337 to get a value of 820 ± 20 mVpp on the Collector pin of Q103

23.1.21 30 MHz Low-Pass Filter Adjustment

Turn the radio on in receive, 30.0 MHz, CW, USB and connect a 50 Ω dummy load to the Exciter RF Out (J102).

Key the radio in transmit and adjust L108, L109 and L110 to maximum signal on the Collector pin of Q103

23.1.22 ALC Check

Connect J102 on the Exciter (Transmit Out) to J1 on LPA (Transmit In) and the output of LPA to a 50 Ω dummy load.

Turn R41 and R42 on the LPA fully clockwise.

Turn R121 on the Exciter fully counterclockwise.

Set the radio to 8 MHz, CW, USB, Hi (high power).

Key the radio in transmit. Adjust R121 to get 200 W RF Out. Do not keep the radio at 200 W for more than 5 seconds. Adjust R41 to get a reading of 150 W RF Out.

Change mode of transmit to Lo (low power) and key the radio and adjust R42 on the LPA board to achieve a reading of 50 W RF Out.

If test fails, verify the following levels:

IC208 pin 2 = $2.6 \pm .1$ VDC HI power without ALC (R41, R42 fully clockwise), 200 W FR Out

IC208 pin 2 = $2.9 \pm .1$ VDC at LO power



IC208 pin 2 = 2.7 ± 1 VDC at HI power

23.1.23 Coupler Port Check

J502 provides a coupler (like the SG-230 Pro and SG-235) with 13.6V and takes receive tuning status indication which is then passed to the Head and displayed as TND.

Putting J501 pin 3 to GND momentarily should have the result of the TND indicator being displayed.

23.1.24 Alarm Generator Check

Connect a 50 Ω dummy load to the SG-2000 RF Out and verify that a 2-tone telephony alarm signal is automatically transmitted in A3J, USB, VOC, Hi PWR modes for 45 seconds by pressing:

SHIFT - keep depressed

EMER - press momentarily

The alarm generator can be stopped at any time by pressing the EMER key.

23.1.25 Power Failure Recovery Check

With the radio in receive, turn the power supply off.

Wait two minutes then turn the power supply back on. The radio should turn on by itself and be in the same frequency and mode as before the power shut down.

TROUBLESHOOTING

This is a list of the most common reasons for test failures. DC and RF levels should be those noted in the Voltages Values tables

23.1.26 Receive Troubleshooting

1) dB S/N at J301 Audio Out is less than 10 dB for PCB versions F and earlier or less than 15 dB for versions G and later.

Check that the attenuator is OFF.

2) No receive in A3H mode

Check that FL202 was selected only

Check that the AM detector voltage levels are correct and that Q506 is turned on.

3) AGC Failure

Set conditions as follows:

any frequency in 1.6 to 30 MHz range

A3J

+90 dB (32 mV RMS) at RF In

R286 adjusted at approximately mid value

dB meter and scope attached to J301 pin 3

You should then read the following voltages:

TP202 = 4.77 ± 0.01 V

TP207 = 4.8 ± 1 V

TP302 = 0.16 ± 0.005 V_{pp}

J301 pin 3 = 6.0 V_{pp}, no clipping

23.1.27 VCO Troubleshooting

1) VCO4, VCO2 and VCO1 failure - frequency is different than the value expected at TP403 (for VCO4), TP401 (for VCO1), TP402 (for VCO2) and the voltage at TP603 and TP601 is zero or 8 VDC.

Check the values of components, check for shorts, check for general line fault conditions along the CLK, DIN and LE lines

2) To check that the PLL works properly, follow the procedure below (example given for VCO2):

Attach frequency counter to TP402

Attach scope to TP402

Attach voltmeter to TP602

Turn on the radio and program in the frequency 10.0 MHz, USB.

- The frequency meter should read 71.64 MHz.
- The scope should read 3 ± 5 V_{pp}.
- The voltmeter should read 5.5 ± 0.2 VDC.

If the frequency is different, remove from the circuit one side of R427.

If the frequency is lower than 71.64 MHz, the voltage on TP602 should be 8 VDC.

If the frequency is higher than 71.64 MHz, the voltage should be 0 VDC.

You should be able to change the frequency below or above 71.64 MHz by adjusting L410 and, if the PLL works correctly, it should change the voltage on TP602 from 8 VDC to 0 VDC. If the PLL works correctly, it may be that the VCO is oscillating outside the limits of the PLL's capacity to adjust. Check for bad components in the VCO.

Repeat the above procedure for any of the VCOs.

23.1.28 Voltage Values for the Exciter PCB

Measurements in the following table were made under the following conditions:

Receive: 10 MHz, A3J, USB, VOC, 32 mV RMS sinusoidal signal from RF generator. AGC at minimum.

Transmit: RF Output of Exciter connected to 50 Ω dummy load.

- J504 and J503 pins 9 and 10 have 1.5 Vpp sin.
- 10,000.0 KHz, A3J, transmit and receive.
- will produce 2.0 Vpp on the Collector pin of Q103 (for Rev H and later boards only, REV G and earlier will produce 2.8 Vpp).
- ALC at minimum.

The Test Area refers to the marked areas on the Exciter schematics (J30100920, sh1-6) following the tables

The following tables give approximate measurements for DC voltage and AC voltage peak to peak for Exciter boards of revision G and earlier and revision H boards.



Test Area	Note	G ±20%	H ±20%
101	Att Off	4.1 V	4.1 V
101	Att on	4.0 V	4.0 V
102	Rx	1.6 V	1.6 V
103	Rx	4.6 V	4.6 V
104	Rx/Tx	4.4 V	4.4 V
105	Tx	6.7 V	6.7 V
106	Tx	6.0 V	6.0 V
107	Tx	2.1 V	2.1 V
108	Tx	2.7 V	2.7 V
109	Tx	7.4 V	7.4 V
110	Rx/Tx	0.0 V	0.0 V
111	Rx	6.7 V	7.3 V
111	Tx	7.2 V	7.3 V
112	Rx	1.3 V	1.4 V
112	Tx	1.4 V	1.4 V
113		0.0 V	0.0 V
114		0.0 V	0.0 V
115	Tx	9.8 V	9.8 V
201	Rx	2.2 V	2.2 V
201	Tx	3.1 V	3.1 V
202	Rx	4.9 V	4.9 V
202	Tx	5.0 V	5.0 V
203	A3H\	7.2 V	7.2 V
204	Rx, A3H	7.3 V	7.3 V
205	Rx	3.0 V	3.0 V
206	Rx	3.0 V	3.0 V
207	Rx, ANT\	4.5 V	4.5 V
208	Rx/Tx	0.0 V	0.0 V
209	Rx/Tx	5.7 V	5.7 V
210	Rx/Tx	6.9 V	6.9 V
211	Tx	1.6 V	1.6 V
212	Rx	3.2 V	3.2 V
213	Rx	3.2 V	3.2 V
214	VOC, RX, AGC\	4.3 V	4.3 V
215	VOC, Rx, AGC\	4.0 V	4.0 V
216	VOC, Rx, AGC\	4.1 V	4.1 V
217	Rx/Tx	5.6 V	5.6 V
218	Rx/Tx	1.4 V	1.4 V
219	Rx/Tx, ALC\	2.6 V	2.6 V
220	Rx/Tx	5.1 V	5.1 V

DC Voltage



301	Rx/Tx	5.1 V		5.1 V
302	Rx/Tx	5.1 V		5.1 V
303	Rx/Tx	5.1 V		5.1 V
304	Rx/Tx	5.1 V		5.1 V
305	Rx/Tx	3.3 V		3.3 V
306	Rx/Tx	3.5 V		3.5 V
307	Rx/Tx	4.8 V		4.8 V
308	Rx/Tx	4.5 V		4.5 V
309	Rx/Tx	7.2 V		7.2 V
310	Rx, A3H\	6.7 V		6.7 V
310	Rx, A3H	0.02 V		0.02 V
311	Rx/Tx	1.5 V		1.5 V
312	Tx, A3H	2.7 V		2.7 V
312	Tx, A3A	2.9 V		2.9 V
313	Tx, A3H	5.6 V		5.6 V
313	Tx, A3A	5.6 V		5.6 V
313	Rx	6.8 V		6.8 V
401	Rx/Tx	3.5 V		3.5 V
402	Rx/Tx	1.5 V		1.5 V
403	Rx/Tx	5.4 V		5.4 V
404	Rx/Tx	2.3 V		2.3 V
405	Rx/Tx	1.4 V		1.4 V
406	Rx/Tx	0.0 V		0.0 V
407	Rx/Tx	2.6 V		2.6 V
408	Rx/Tx	2.0 V		2.0 V
409	Rx/Tx	2.2 V		2.2 V
410	Rx/Tx	6.3 V		6.3 V
411	Rx/Tx	1.5 V		1.5 V
412	Rx/Tx	2.6 V		2.6 V
413	Rx/Tx	0.0 V		0.0 V
414	Rx/Tx	0.71 V		0.71 V
415	Tx, A3H\	3.2 V		3.2 V
416	Rx/Tx	2.3 V		2.3 V
417	Rx/Tx	1.7 V		1.7 V
418	Rx/Tx	7.9 V		7.9 V
601	Rx/Tx	5.4 V		5.4 V
602	Rx/Tx	5.3 V		5.3 V
603	Rx/Tx	1.4 V		1.4 V
604	Rx/Tx	-1.3V		-1.3V
605	Rx/Tx	5.3 V		5.3 V
606	Rx/Tx	0.07 V		0.07 V
607	Rx/Tx	5.1 V		5.1 V
608	Rx/Tx	5.1 V		5.1 V

DC Voltage



Test Area	Note	G ±20 %	H ±20 %
103	Rx	150 mVpp	150 mVpp
104	Rx	150 mVpp	150 mVpp
104	Tx	120 mVpp	70 mVpp
105	Tx	1.2 Vpp	600 mVpp
106	Tx	1.1 Vpp	520 mVpp
107	Tx	70 mVpp	50 mVpp
108	Tx	0.0 mVpp	0.0 mVpp
109	Tx	1.1 Vpp	600 mVpp
110	Tx	110 mVpp	70 mVpp
110	Rx	165 mVpp	165 mVpp
111	Tx	210 mVpp	100 mVpp
111	Rx	4.0 Vpp	4.0 Vpp
112	Rx	95 mVpp	95 mVpp
113	Rx	900 mVpp	900 mVpp
113	Tx	50 mVpp	30 mVpp
114	Rx	1.1 Vpp	1.1 Vpp
114	Rx, A3J	90 mVpp	50 mVpp
114	Tx, A3H, No Mic	60 mVpp	30 mVpp
114	Tx, A3A, No Mic	30 mVpp	20 mVpp
115	Tx, A3J	2.8 Vpp	2.0 Vpp
201	Rx	1.0 Vpp	1.0 Vpp
201	Tx	160 mVpp	80 mVpp
202	Rx	700 mVpp	700 mVpp
202	Tx	650 mVpp	340 mVpp
205	Rx	225 mVpp	225 mVpp
208	Rx	80 mVpp	80 mVpp
208	Tx	300 mVpp	150 mVpp
209	Tx, A3H	200 mVpp	200 mVpp
210	A3H	590 mVpp	590 mVpp
211	Tx	870 mVpp	460 mVpp
212	Rx	235 mVpp	235 mVpp
215	Rx, A3J	3.8 Vpp	3.8 Vpp
217	Tx	300 mVpp	150 mVpp
218	Tx	515 mVpp	220 mVpp

AC Voltage Peak-to-Peak



301	Tx	470 mVpp		240 mVpp
301	Rx	2.5 Vpp		2.5 Vpp
302	Rx	850 mVpp		850 mVpp
302	Tx, CW	190 mVpp		170 mVpp
303	Rx	4.0 Vpp		4.0 Vpp
303	Tx	1.0 Vpp		1.0 Vpp
304	Rx	4.0 Vpp		4.0 Vpp
304	Tx	1.0 Vpp		1.0 Vpp
305	Rx	90 mVpp		1.0 Vpp
309	Rx	2.0 Vpp		2.0 Vpp
311	A3H	80 mVpp		80 mVpp
311	Tx, A3A	50 mVpp		30 mVpp
313	Tx, A3H	85 mVpp		60 mVpp
314	Rx, .5 μ V RF In	3 Vpp		3 Vpp
315	Tx, .3 μ V RF In	1.5 Vpp		600 mVpp
401	Rx, Tx	400 mVpp		400 mVpp
403	Rx, Tx	1.4 Vpp		1.4 Vpp
404	Rx, Tx	800 mVpp		800 mVpp
406	Rx, Tx	3.0 Vpp		3.0 Vpp
407	Tx, Tx	500 mVpp		500 mVpp
408	Rx, Tx	200 mVpp		200 mVpp
410	Rx, Tx	600 mVpp		600 mVpp
413	Rx, Tx	2.5 Vpp		2.5 Vpp
414	TX, A3H	12 Vpp		12 Vpp
416	Tx, A3H	600 mVpp		600 mVpp
418	Tx, A3H	1.2 Vpp		1.2 Vpp
501	Rx	1.0 Vpp		
501	Tx, CW			700 mVpp
502	Rx	1.0 Vpp		
502	Tx, CW			700 mVpp
602	Rx, Tx	10 Vpp		
605	Rx, Tx	6 Vpp		
606	CW	150 mVpp		
607	CW	200 mVpp		
608	CW	200 mVpp		

AC Voltage Peak-to-Peak



J30100920 sh 1



J30100920 sh 2



J30100920 sh 3



J30100920 sh 4



J30100920 sh 5



J30100920 sh 6

23.2. LPA Testing Procedures

This section details the procedures for testing the LPA PCB of the SG-2000 radio.

23.2.1 Required Testing Equipment

Working LPA sample
12 inch/lbs calibrated torque wrench
RF Signal Generator with capability of +3 dBm 1.6-30 MHz RF out
Power Supply Capable of at least 30 Amps at 13.6 Volts (PS-35)
Connection Cables
Spectrum Analyzer
Tracking Generator
Multimeter
50 ? 200 W Dummy Load Antenna 30 dB attenuator
Watt Meter and 250 W slug
SGC LPA Test Box, SGC-Twin Current Meter
Variable Power Supply 5-40 V, > or = 2A

23.2.2. Circuit description

The LPA (linear power amplifier) has two pages to the schematic, J30100500. Transmit RF is received from the exciter on connector J1. The signal is amplified by Q1. Transformer T2 splits the signal for the Class "B" amplifier containing transistors Q2 and Q3. The signal is combined and then split again for the dual Class "B" final amplifier containing transistors Q6, Q7, Q10 and Q11. The signal is recombined and sent to the filter section. Note: the final amplifiers get power directly from the power supply. The filter section is controlled by IC3 and IC4. There are six low pass elliptical filters which are selected based on the transmit and receive frequencies. Relay K1 switches the filters between the transmit and receive paths.

The forward and reverse RF power is detected by transformers T13 and T14. The signals are rectified. The rectified signals are used for the ALC (automatic level control), VSWR shutdown and the analog to digital converter, IC5. The digitized signals are sent to the exciter where they are eventually used to drive the VSWR and FWD meter on the display.

The SG-2000 has protection from over and reverse voltages as well as transient spikes. The voltage protection circuit uses a normally open relay which is only closed when the proper voltage is applied. Diode D1 prevents current from flowing during reverse polarity conditions. Transistors Q19, Q20 and Q21 form a logic switch. Diode D11 sets the level of the logic switch. During normal operation, transistor Q20 is on and Q19 and Q21 are off. Current flows through

Q20 and D1 energizing the relay, K14. If a voltage in excess of the zener breakdown voltage of D11 is applied, transistors Q19 and Q21 turn on and Q20 turns off. Diode D13 provides protection from transient voltage spikes.

23.2.3 Test Setup

Ensure screws holding the final transistors; Q6, Q7, Q10 and Q11 have 12 inch lbs. of torque.

Using the LPA sample board, visually check:

Check all electrolytic capacitors for polarity.

Check for any solder bridges.

Ensure R21 is not touching the PCB.

Install any missing parts, except IC3, IC4, F1, F2 and F3.

Check the orientation of transistors and other parts.

Check the wires on T10 and T8. The colors should alternate green and red.

Check the wires on T6. They should crisscross as shown in the figure below. Notice, the order of the wires on the teroid does not have to be the same order as the solder connections.

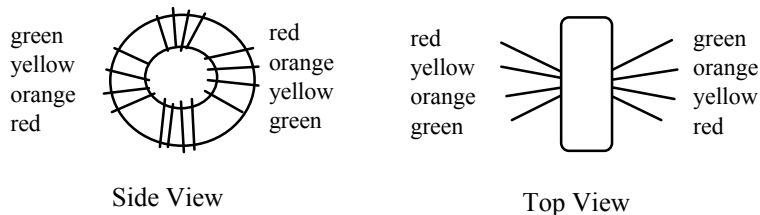

Set the resistors,

R20	to	approximately mid value
R28	to	approximately mid value
R2	to	approximately mid value
R32	to	approximately mid value
R41	to	fully clockwise
R42	to	fully clockwise



Note on using HP8443A Tracking Generator as an RF generator

The HP8443A Tracking Generator can substitute for an RF Generator with changes to the following settings:

- If connected to the Spectrum Analyzer, turn CRT intensity on Analyzer to minimum.
- (Scanning) Mode = scan hold.
- Set RF Out to -3 dB before transmitting. Adjust the RF out only when not in transmit.

Open the windings on inductors L1 through L15 to their maximum.

Use the multimeter in the Ohms position. Make the following readings with reference to ground.

Check that all pins on J15 except 5 and 6 are connected to GND and have a resistance = 1 K

Check for the following values:

IC5 pin 1 approximately 10 K

IC5 pin 5 approximately 2.0 M

IC5 pin 7 approximately 2.0 M

Fuse F3 output > 1.0 M

Collector Q6, Q7, Q10, Q11 > 500 K

Base Q6, Q7, Q10, Q11 ~ 11.2 ?

Pin 4 of IC2 > 400 ?

Base Q2 and Q3 ~ 23 ?

23.2.4 Voltage Protection (Rev E Boards ONLY)

Note: Safety glasses should be worn while testing the voltage protection circuit.

• Out of Range Voltage Supply (Rev E and Later Boards ONLY)

Use the variable power supply set on the lowest voltage setting. Connect the positive power lead to J12. Connect the negative power lead to J14.

Watch the current meter on the power supply as you turn on the power supply. Turn off the power supply if I = 1A and troubleshoot the problem. Increase the supply voltage until relay K14 closes. Record the supply voltage. Continue to increase the voltage until relay K14 opens again. Record the supply voltage.

Relay Closes between 9 and 10.5 Volts

Relay Opens between 19 and 20 Volts

Increase the voltage to 40 V, keep it there for 3-5 seconds and decrease to 0. Observe K14 turning on and off when it reaches the above voltages.



Reduce the voltage to zero and turn off the power supply.

- **Reverse Voltage (Rev E Boards ONLY)**

Reverse the power supply connections on the LPA.

Watch the current meter on the power supply as you turn on the power supply. Turn off the power supply if there is any current and troubleshoot the problem. Increase the supply voltage to 40 V. Relay K14 should stay open all the time.

Reduce the voltage to zero and turn off the power supply.

23.2.5 Filter Bands Sweep

This test will check for the upper edge of the 6 low pass filters by sweeping them using the Tracking Generator and Spectrum Analyzer.

Compare the values displayed on the Analyzer to the values on the Filter Band Table below. The values should be within -0 to +10%.

Knob	Filter Band	Frequency (MHz) High End
6	A	2.8
5	B	4.5
4	C	8.9
3	D	15.5
2	E	20.6
1	F	30.0

Filter Band Table

Procedure:

Install F3 and keep F1 and F2 removed.

Connect the LPA Test Box to LPA as follows;

C3 to IC3 socket

C4 to IC4 socket

C15 to J15

Set the switches in Receive position, Power off.

Connect Tracking Generator RF Out to J9 (RCVR) and set it to 0 dB RF Out.

Connect Spectrum Analyzer RF In to output dummy load antenna and set it to 5 MHz/division, 10 dB input attenuation.

Connect Power Supply (PS-35) 13.6V to J12 + and J14 -.

Turn Power Supply on, 13.6V indicator on Test Box should come on.

Turn Test Box Power switch on, 10V indicator should come on.

From Test Box Filter Band Select Knob (SW2), select each filter (A through F) by moving Knob from position 6 to 1.

The Spectrum Analyzer should display the bandpass of the corresponding filter. Compare the Analyzer value with the value of the corresponding filter in the Filter Band Table above. Results should be within $\pm 10\%$.

Momentarily flip the LPA to transmit (SW1 flip to XMT) and observe the curve on the Analyzer. It should show an interrupted circuit.

Disconnect the Analyzer and Tracking Generator.

Turn Power Supply off

23.2.6 Transmit Alignment

Disconnect Spectrum Analyzer and Tracking Generator.

Connect LPA RF Out to a 250 W wattmeter and then to a 50 Ω dummy load antenna (= 30 dB attenuator). The output of the attenuator goes to the scope.

Select any filter on the LPA from the Test Box.

Check that F2 and F3 are not installed. Turn power supply on and apply voltage to the LPA.

Switch to transmit and check the following voltages:

- collector of Q1 = 13.6 V (in transmit only)
- collector of Q2 and Q3 = 13.6 V (in transmit and receive)
- base of Q1 = 1.9 V, adjustable from R2
- emitter of Q1 = 1.2 V
- base of Q2 and Q3 = .70 VDC, adjustable from R32
- base of Q6, Q7, Q10 and Q11 = .67 VDC adjustable from R20 and R28

Turn power supply off and connect 20 A amp meters in the place of F1 and F2.

Select Filter A (6 on dial)

Connect RF Generator to RF In (J1) on LPA with 0 dB, 1.6 MHz RF Out.

Switch to transmit and watch for:

- current on Power Supply should never go higher than 32 A for 150 W RF Out
- the twin current meters should not differ by more than 4 A. Use R20 and R28 to bring them to = 2 A difference.

Adjust the coils in the selected filter for lower current and higher RF Out, especially in the end of band frequencies.

If RF Out from LPA is less than 140 W, increase the RF Out from the Generator (to no more than +3dB) until the power out is 140-160 W.

Note in the LPA Alignment form:

- RF In level from RF Generator (between -1 to +3 dBM)
- RF Out level from LPA (between 140-160 W)
- F1 and F2 current on corresponding amp meter
- Power Supply current

Repeat above for all frequencies listed in the Filter Band Table above, making sure the proper filter has been selected manually from the Test Box before each frequency is tested.

23.2.7 ALC Check

Automatic Level Control (ALC) consists of sensors T13, T14, amplifiers IC2 A, C and D, buffer IC2 B on the LPA and IC208 on the Exciter.

Preset levels for Low and High power out are adjustable form R41 and R42 and control the amount of signal the IC8 attenuator on the Exciter lets reach the LPA, therefore the amount of RF Out reaching the antenna.

On the Test Box, turn SW3 to RCV and turn power on (SW1).

Change modes of power from SW5, adjust R41 and R42 and check the voltage on TP1 on Test Box as follows:

<u>Mode</u>	<u>R41 and R42</u>	<u>R41 and R42</u>
(SW5)	Fully Clockwise	Fully Counterclockwise
High (L5=off)	0.08 ±0.02 VDC=V1	6.3 ± 0.2 VDC
Low (L5=on)	4.8 ±0.2 VDC=V2	6.3 ±0.2 VDC

Note: L5 on Test Box will indicate that Q14 on LPA is biased for not conducting, and corresponds to Low power mode.

Switch RF In to 8.0 MHz and select the appropriate filter on the LPA

Turn R41 and R42 fully clockwise.

Adjust RF In from RF Generator for 150 W RF Out from LPA, in transmit into 50 ? dummy load antenna.

With SW5 on High power, switch to transmit and note the voltage level at TP1 on Test Box. Write this value as V1 on the test form.

With SW5 on Low power, switch to transmit and note the voltage level at TP1 on Test Box. Write this value as V2 on the Test form.

Verify that $V2 - V1 = 4.5 \text{ VDC} \pm 0.5 \text{ VDC}$.

23.2.8 Temperature Sensor Check

The Temperature Sensor is built around IC1 on the LPA board and functions as follows:

At room temperature, the voltages on pins 1, 2 and 3 of IC1 are as follows:

IC1 pin 1 = 3.6 VDC

IC1 pin 2 = 0.05 VDC

IC1 pin 3 = 0.92 VDC

When the temperature of the heatsink reaches;

+55° C ±5° C (the low temperature trigger) the voltage on pin 2 of IC1 is = the voltage on pin 3. This will cause the voltage on pin 1 of IC1 to drop to near 0, which will be sensed by the Main CPU board. Data will be sent 1) to the Head to flash the TEMP indicator, 2) to IC4 to pull pin 14 low (IC1 pin 2 will again go lower than pin 3 and pin 1 will go higher) and 3) to IC4 to pull pin 13 low to start the fan running.

+70° ±5° C (high temperature trigger) 1) the fan will continue running, 2) IC4 pin 15 will go low which will switch the radio to Low Power transmit mode and 3) LO PWR will be displayed on the Head and the TEMP indicator keeps flashing.

On LPA Test Box, SW4 is a 3 position switch

Middle = L4 will stop lighting when temperature reaches low temp trigger point

Right = L4 will stop lighting when temperature reaches high temp trigger point.

Left = Simulation of low temp trigger point

In normal LPA testing on the bench, the temperature of the heatsink at thermister R75 is not allowed to reach trigger points. LPA Test Box simulates the increase of resistance with temperature and reaching the low temperature trigger points when SW4 is in the left position.

On LPA Test Box, turn SW3 to RCV position.

Flip SW4 through the 3 positions. If the temperature is less than $55^\circ \text{ C} \pm 5^\circ \text{ C}$, L4 will stop lighting only in the Left position.



Turn power supply off.

23.3 DISPLAY SECTION TESTING PROCEDURES

This section describes the testing procedures for the Display section of the SG-2000 radio.

23.3.1 Required Testing Equipment

HP 331A Distortion Analyzer
HEATH KIT IG-5218 Audio Signal Generator or equivalent
PS-30 13.6V power supply
SGC Display RX Audio Test Fixture
Power Supply Capable of at least 2 Amps at 13.6 Volts for connecting the SG-2000 to the PS-30 power supply
Connection Cables; CPU extension cable
Keyboard extension cable
DMM
SG-2000 Test Head
SG-2000 without head, RF Out adjusted to minimum, bypassed AM filter.
SG-2000 Test Head Microprocessor With Display Test Chip (IC16)
SG-2000 Test Head Microprocessor With Normal Chip (IC16)
SG-2000 Sample Display Boards (1 working and 1 bare PCB, latest rev)
Oscilloscope
Microphone PTT Toggle Switch
Microphones; 1 carbon, 1 dynamic

23.3.2 Circuit Description

The display board provides the keypad board interface, volume control, microphone amplifier, display interface, and back light control. The circuit can be seen on schematic J30100910. Information is received from the key board matrix on connector J3 and is passed to the head processor board on connector J2. The one exception to this is the on/off switch; it is passed from connector J3 to the exciter in connector J1.

The line receiver takes the balanced audio signal coming from the exciter and converts it into an unbalanced signal for the volume control. Volume control is provided by using a digital to analog (D to A) converter, IC16. In addition, the received audio signal is rectified by IC12B and fed to the analog to digital (A to D) converter, IC14. IC14 also converts the photo cell voltage (on Rev E boards and earlier) and sends output to the head processor via pin 12 on J2. Jumper J6 is used to select either a dynamic (factory setting) or carbon microphone. The audio signal is converted from an unbalanced signal to a balanced signal by the line driver, IC11A and B. The balanced audio signal is sent to the exciter through J1. When in CW mode, the CW signal is received from the exciter and treated as

if it were a receive signal. The speaker is enabled by holding SPE low in CW mode.

The receive audio signal is digitized for use by the squelch by over driving IC12A. The output on pin 7 of IC12A is a clipped version of the receive audio signal. This is inverted by IC13A which is the TMR signal. The TMR signal has a pulse repetition rate equal to the receive audio frequency.

23.3.3. Test Setup

Visual inspection. Look for any quality defects.

Check all diodes and electrolytic capacitors for polarity.

Check for solder bridges and shorts. Compare to the sample display board.

Use the multimeter in the Ohms position. Check for short circuits on the VREF, 5VG, 5V, 8VG, 13.6VSW and OVEN lines.

Connect SG-2000 remote head cable from J503 on the SG-2000 to J1 on the display board under test.

Connect extender cable from J1 on the Test Head Microprocessor Board With Display Test Chip to J2 on the display board under test.

Connect keyboard extender cable from J1 on the Test Head board to J3 on the display board under test. (At this stage there is no LCD installed on the PCB).

Connect the RF output of the SG-2000 to a power meter and then to a 50? dummy load.

LCD Installation

Turn on the power supply. After the standby LED comes on, apply power to the display by pressing the "POWER" button on the head.

Test for the following voltages.

5 VDC on each side of R13

5 Vpp clock of 65 Hz on each side of R12

Turn the power off.

Install new LCD, lamps and foam. See the working sample of Display PCB on the Display PCB under test.



Voltage Check

Turn power on.

Using the multimeter, test each test point for the following voltages:

Cathode D1 13.6 VSW (same as power supply)

Output IC1 8 VG +/- 0.3 V

Output IC2 5 VG +/- 0.2 V

Output IC3 5 V +/- 0.2 V

Pin 1 IC12D V REF (4V +/- 0.3V)

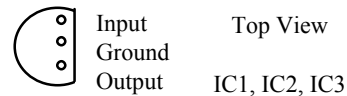

23.3.4 LCD Display Test

The Display Test Chip has a special program to exercise the LCD (liquid crystal display) by sequencing through all of the possible display outputs. The sequence is reset to 1 whenever the power is turned off. All keys on the head are disabled except for the following three:

The POWER key functions as normal.

The VOL. key starts the sequence or resumes the sequence if paused.

The six key pauses the sequence.

Press the VOL. key to start the sequence. Look for imperfect appearance of digits - digits continually on or off, not complete, etc.

Pause the sequence if any of the steps do not provide the expected output and troubleshoot the problem.

Turn off the radio and then the power supply.

23.3.5. Receive Audio Test

Setup - See Configuration schematic.

Remove the Test Head Microprocessor With Display Test Chip and replace with Test Head Microprocessor With Normal Chip.

Connect the Display RX Audio Test Fixture as follows (see setup schematic):

One banana plug to the audio signal generator sine wave out.

One banana plug to the input of the distortion analyzer.

SPKR connector to B.U.T. J5.

FONE connector to B.U.T. J4.

Audio connector replaces wires 9 and 10 of J1 remote cable.

Turn on the power supply and then the radio. Set the radio to the base station frequency in A3J mode.

Set the Oscilloscope:

Vertical = 1 volt/div.
Horizontal = 0.2 msec/div.

Set the Distortion Analyzer:

Function = Voltmeter
Meter Range = 1.0 VRMS

Set Audio Generator:

Load = External
Frequency = 1 KHz
Amplitude = 0 VRMS

23.3.6 S Meter Test

Adjust the amplitude of the audio signal generator for a full scale reading on the S meter. Full scale should correspond with a 10 dB increase from a 0 (no segments) indication of signal strength. Record the VRMS amplitude and dB level on the Distortion analyzer.

	<u>Full display</u>	<u>zero display</u>
Amplitude	.3 to .4 VRMS	.03 to .05 VRMS
dB	-4 dB	-15 dB

Reduce the amplitude of the audio signal until there are zero bars on the S meter.

Record the dB difference on the Distortion analyzer. This should be:

? dB = 10dB ? 2 dB -4 dB - (-15 dB) = 11 dB

If test fails, check IC14 pin 2. For .5 VRMS Audio Input from generator, it should read 2.7 VDC and for .05 VRMS it should read .2 VDC.

23.3.7 Speaker Level Check

Change the distortion analyzer to 0.3 VRMS range.

Adjust the audio generator for 100 mVRMS reading on the distortion analyzer.

Increase the audio volume to the maximum level.

Measure and record the voltage across the SPKR resistor with the oscilloscope. Ensure the speaker is enabled, signal should be a clean sine wave:

SPKR = 8 Vpp to 10Vpp

If test failed, check for the following levels:

IC11 Pin 9	.05	Vpp
IC11 Pin 10	.05	Vpp
IC11 Pin 8	540	mVpp
IC16 Pin 8	540	mVpp
IC16 Pin 11	60	mVpp
IC20 Pin 2	5	mVpp
IC20 Pin 1	.5	Vpp
IC18 Pin 1	.3	mVpp
IC18 Pin 4	8-10	Vpp

23.3.8 Phone Level Check

Turn speaker off by pressing SPKR 4 key, increase volume to the maximum level then measure and record the voltage across the FONE resistor with the same 100 mV audio signal.

FONE = .6 to .8 Vpp

If test fails, check for the following levels:

IC19 Pin 9	.5	Vpp
R81 & C44	60	mVpp
IC17 Pin 3	40	mVpp
Output	.6 to .8	Vpp

23.3.9 Squelch Test

The squelch (SQL) function will keep the receiving path into the speaker open as long as the received signal is of broadcasting structure and its strength meets the SQL's minimum level, preset by the user.

The SQL level can be set from the keyboard from a range of 0-9 as follows:

Press	Effect.
SHIFT	Gain access to the secondary level of keyboard functions.
SQL LEVEL	The currently set squelch level is displayed on the bar graph and is able to be modified.

Up or Down Arrows

or 0-9 Selects a new squelch level which will take effect if no other button is pushed for 6 seconds.

Audible beep after

6 seconds Confirmation that the last displayed number is the new squelch setting.

SQL Toggles the squelch on or off.

Test Procedure:

Program the SG-2000 to a local AM broadcasting station.

Turn volume to medium level.

Set SQL level to 1.

Enable SQL function: the audio will be cut off.

Switch the SG-2000 antenna from the dummy load to the aerial antenna (SW2). The broadcasting signal should break in and should be heard on the SKK.

Switch the SG-2000 antenna back to the dummy load. Without the broadcasting signal, the SQL will cut off the audio.

Troubleshooting

If the test fails, switch SW1 to the audio generator input and inject 100 mVRMS, 1 KHz. You should read a 4 to 5 Vpp square wave on IC13A pin 12 and 5V level data on IC13A pin 11.

23.3.10 Speaker Clipping Level Check

Connect the scope probe to the SPKR resistor and change to 2 volts/div.

With volume set at maximum, increase the audio generator output level until clipping is visible on the scope. Record the results.

Audio in = 0.12 VRMS to 0.19 VRMS
SPKR = 10 Vpp to 12.0 Vpp

Verify that no spikes are generated on the scope while adjusting the volume up and down.

Turn off the radio and power supply. Disconnect the Display RX Audio Test Fixture.

**Transmit Tests
Enabling Test****23.3.11****Microphone**

Connect the microphone and speaker cables from the test head to J4 and J5 respectively.

Turn on the power supply and then the radio. Set the radio to the base station frequency in A3J mode.

Connect the Microphone PTT Toggle Switch to the microphone input on the test head. Ensure the switch is off. Connect the audio generator to the Microphone PTT Toggle Switch.

Set Audio Generator for.

Load = External
Frequency = 1 KHz
Amplitude = 30 mVRMS (measure with voltmeter)

With J6 in the DYN configuration, adjust the volume to the maximum. Listen for the 1 KHz tone from the generator on the speaker. If any tone can be heard, check Q3; it could be defective.

23.3.12 Dynamic Microphone Level Check

Select DYN on J6 for dynamic microphone.

For level check without a voice compressor, set jumpers P7 and P8 in Bypass position.

For 30 mVRMS, 1 KHz sinusoidal on microphone input j4, adjust R66 for 1.5 Vpp to GND on pins 9 and 10 of J1.

For level check with a voice compressor, to achieve 5 mVRMS to VRMS variation of 1 KHz sinusoidal on microphone input J4, adjust R66 and R1 on voice compressor for constant 1.5 Vpp to GND on pins 9 and 10 of J1.

23.3.13 Carbon Microphone Level Check

Do not readjust R66 or R1 as in Dynamic Mic Level Check. They remain set as shipped from factory.

For ---VRMS, 1 KHz sinusoidal, without voice compressor, on microphone input J4, the reading on pins 9 and 10 of J1 should be 1.5 VRMS.

For ---VRMS, 1 KHz sinusoidal, with voice compressor, on microphone input J4, the reading on pins 9 and 10 of J1 should be 1.5 VRMS.

23.3.14 Microphone Voice Check

With J6 in CARB configuration, plug in an SGC carbon microphone and check with the base station for quality of transmission.

With J6 in DYN configuration, plug in an SGC dynamic microphone and check with the base station for quality of transmission.

Beep Volume Adjustment

Set resistor R87 to 1 o'clock.

Enable the beep by pressing "SHIFT FUNC" and then "5".

Adjust R87 for a comfortable audio level while pressing buttons.

23.3.15 Button Functions

Check that all of the button functions react properly (see manual for details) and that they have the correct readout on the display.

23.4 HEAD CPU and MAIN CPU TESTING PROCEDURES

This section describes the test procedures for the SG-2000's Main CPU and Head CPU subassemblies.

23.4.1 Required Testing Equipment

HEATH KIT IG-5218 Audio Signal Generator or equivalent
Power Supply Capable of at least 2 Amps at 13.6 Volts between the SG-2000 and the PS-30
Connection Cables; CPU extension cable
Remote Head Cable
DMM
SG-2000 Head
SG-2000 Chassis
Oscilloscope
Microphone PTT Toggle Switch
Digital Logic Probe
PS-30
SGC 6805 ports test board, with software
Head CPU bare board sample
Head CPU functional sample
Known good set of socketed ICs

23.4.2 Circuit Description

The Head Processor CPU is a one page schematic, J30100935.

The Head Processor board uses the same Printed Circuit Board (PCB) as the Main Processor board. The two processors communicate with each other over the SIN and SOUT lines. The main functions of the head processor are to control the display, keyboard and audio levels. This is all done in software on the MC146805E2 microcomputer. The software resides in EPROM on IC16.

The Main Processor is a two page schematic, J30100930.

The Main Processor board uses the same PCB as the Head Processor board. The two processors communicate with each other over the SIN and SOUT lines. The main functions of the Main Processor are to select the proper frequency and to control the various modes of the SG-2000.

23.4.3 Pretest

Visual inspection. Look for any mechanical defects.

Check for solder bridges, wrong parts installed, and shorts by comparing to the sample head processor board. Check all five jumpers.

Use the multimeter in the Ohms position. Check for short circuits on the 5VG, 5VSW and 13.6VSW lines. Note: the 5VG and 5VSW lines are connected together by jumper JMP5.

23.4.4 MicroProcessor Ports Test

Connect SGC Processor Ports Test Board to 13.6 V power supply.

Connect the ribbon connector on board test board to J1 on the head processor board under test.

Install the SGC 6805 Processor Ports Test Chip in the IC16 socket on the CPU.

Install the MicroProcessor chip in IC9 and all other socketed ICs.

Turn on Ports Test power switch. The following should be checked.

The Port A LEDs should strobe from A0, A1, ..., to A6 then A7.

The Port B LEDs should strobe from B7, B6, ..., to B3 then B2. Note: LEDs B0 and B1 should not light up.

The TPR LED should also be on.

Press the TPR button. The TPR LED should go out while the button is pushed and turn back on when released.

The Data LED should be lit.

If the board fails one of these checks, turn off the Ports Test Board. Uninstall the socketed ICs one by one in this order: IC19, IC18, IC7, IC11, and IC8 to find the problem area. Use the digital logic probe in the TTL position to trouble shoot the board.

Repeat MicroProcessor Ports Test after every IC removal.

23.4.5 Clock Test

Measure and record the frequency at IC10.

<u>Pin</u>	<u>Frequency</u>
5	153.6 KHz +/- 63 Hz
9	4,915.2 KHz +/- 2 KHz

Measure the frequency on IC7 pin 3 and adjust C14 so that a reading of 32,768 Hz is obtained.

23.4.6 Data In/Out Check

This procedure tests if data signals are reaching TXD and RXD on UART (IC8).

Data Out Check

Press SW5 (RS-232 out). DS3 (SG-2000 out) should turn off and DS4 (RS-232 out) should turn on. Releasing SW5 will return to original stage.

RS-232 Data In Check (Main CPU only): Press SW3 (RS-232 Sin). IC8 pin 2 should go to 0 VDC from pulsing.

SG-2000 Data In check: Press SW4 (SG-2000 Sin). IC8 pin 2 should go to 0 VDC from pulsing.

23.4.6 Battery Installation (Main CPU only)

(Note: The presence or absence of the battery will not affect the tests described so far.)

Remove +.

Check the place where the battery will be installed with a DMM in the ohms position, it should read not less than 3 M? .

The battery should read not less than 2.8 VDC before being soldered onto the CPU.

Secure the battery with foam before soldering it on top of IC14 and IC 12.

While the CPU is removed from the radio, check that pin 2 of IC7 reads 2.8 VDC.

The Main Processor uses a "real time clock," IC7, to keep time and store important data while there is no power to the SG-2000. While power is applied to the SG-2000, capacitor C31 charges to 5.5 volts. When power is removed, capacitor C-31 will discharge through Q2. This keeps the battery power turned on. After two weeks, the charge in C31 is reduced to the point that Q2 turns off. This prevents the battery from fully discharging. This method of using a battery and capacitor provides a much longer life span than a NiCad battery and gives the same performance.

23.4.7 Operational Test

Remove the CPU from the Ports Test Board and replace IC16 with normal software.

Connect the CPU through an extension cable to the SG-2000's head (for Head CPU) or SG-2000's Exciter (for Main CPU).

Turn on the power at the head.

Verify that all keys operate and perform proper functions (consult other sections of this manual for complete descriptions of proper functions).

Functions that should be checked:

Keeping a programmed time, date, channel and frequency on display for 30 seconds after the PS-30 has been turned off.

Alarm Generator

ON/OFF function from head

Program then erase a channel

C31 charging check (Main CPU only).

Place the Main CPU tested on the CPU charger for not less than 15 minutes.

Ten minutes after the Main CPU is removed from the charger, check that the voltage across C31 is still no less than 5VDC.

23.4.8 Reference Logic

IC2 is a 5 volt regulator, 78L05.

IC3 is a Dual 2-to-4 Line Decoder, 74HC139.

Truth Table
IC3A

Inputs			Outputs
G P1	A4 P2	A5 P3	Y3 P7
H	X	X	H
L	L	L	H
L	H	L	H
L	L	H	H
L	H	H	L

Truth Table
IC3B

Inputs			Outputs	
G P15	A6 P14	A7 P13	Y2 P10	Y3 P9
H	X	X	H	H
L	L	L	H	H
L	H	L	H	H
L	L	H	L	H
L	H	H	H	L

IC4 is a Quad 2-Input NAND Gate, 74HC00.

Truth Table
IC4C

Inputs		Outputs
A2 P10	A3 P9	P8
L	L	H
L	H	H
H	L	H
H	H	L

H = high

L = low

IC5 is a Triple 3-Input NOR Gate, 74HC27.

Truth Table
IC5B

Inputs			Outputs
A2 P3	A3 P4	Y3 P5	UCE P6
L	L	L	H
X	X	H	L
X	H	X	L
H	X	X	L

H = high

L = low

X = don't care

IC6 is a Quad 2-Input NOR Gate, 74HC02.

Truth Table
IC6A

Inputs		Outputs
A8 P3	A9 P2	P1
L	L	H
L	H	L
H	L	L
H	H	L

H = high

L = low

IC8 is an Asynchronous Communications Interface Adapter (ACIA), HD63B50. The data rate = RxC or $TxC / 16$. Normally this is set to 9600. The parallel input/output lines are B0 through B7.

The Transmit Data (TxD pin 6) is the serial output line. It is normally "high" when not in use.

The Receive Data (RxD pin 2) is the serial input line. It floats at about 2.5 volts when not in use.

Enable (E pin 14) enables the bus input/output data buffers and clocks data to and from the ACIA.

Chip Selects (CS0, pin 8, CS1, pin 10, and CS2 bar, pin 9) are high impedance TTL compatible input lines used to address the ACIA. The ACIA is selected when CS0 and CS1 are "high" and CS2 bar is "low". Transfers to and from the ACIA are then performed under the control of the Enable (E) signal, Read/Write, and Register Select.

Register Select (RS, pin 11). A "high" level is used to select the Transmit/Receive Data Registers and a "low" level the Control/Status Registers. The R/W line is used in conjunction with Register Select to select the read-only or write-only register in each register pair.

Read/Write (R/W pin 13) is used to control the direction of data. A "high" on the Read/Write enables the read-only register and a "low" enable the write-only registers.

Interrupt Request (IRQ bar) is an open drain (no internal pull-up) active "low" output interrupt that is set internally to the chip. The IRQ bar stays low as long as the cause of the interrupt is present within the ACIA.

The Clear-to-Send (CTS bar, pin 24) should be connected to ground.

Data Carrier Detect (DCD bar, pin 23) is the input signal corresponding to the "carrier detect" signal which shows carrier detect from a modem. When the DCD bar goes "high," the ACIA stops all the receiving operation and sets the receiving part in reset status. The IRQ bar goes "low" if interrupt enable is set, while DCD bar is "high." When the DCD bar goes "low," the receiving part is allowed to receive data. The DCD bar should be connected to ground.

IC10 is a Asynchronous 14-Stage Binary Counter and Oscillator, SN74HC4060. A crystal oscillator is connected between pins 10 and 11. The clock frequency can be measured at pin 9. The frequency at pin 5 = frequency pin 9 / 32. The frequency at pin 7 = frequency pin 9 / 16.

IC15 is a Tri-State Octal D-Type Latch, 74HC373. Data is received on pins 7, 14, 8, 13, 4, 17, 3, and 18, which correspond to data lines B0 through B7 respectively. Data is output on pins 6, 15, 9, 12, 5, 16, 2, and 19 which correspond to data lines A0 through A7 respectively.

Truth Table
IC15

Inputs		Outputs
AS P11	B0-B7	A0 - A7
L	H	H
L	L	L
H	X	Q ₀

H = high

L = low

Q₀ = level of output before steady-state input conditions were established.

IC16 is a 65,536-Bit Erasable Programmable Read-Only Memory, 27C64-20. Lines A0-A7 are the address and B0-B7 are the data output lines. Data is output when CE bar, pin 20, and OE bar, pin 22, are low. Otherwise, the output is in a high impedance state.

IC7 is a Real-Time Clock Plus Ram (RTC), MC146818.

Pin 3 ~ 4.5 V_{pp} @ 32.768 KHz

Chip Enable (CE bar pin 13) must be "low" for a bus cycle in which the MC146818 is to be accessed. CE bar is not latched and must remain stable during the cycle.

Read/Write (R/W pin 15) is used to control the direction of data. A "high" on the Read/Write enables a read cycle and a "low" a write cycle.

23.5 FINAL ASSEMBLY TESTING PROCEDURES

In addition to the checks, tests, adjustments, measurements and calibrations the individual PCBs go through, each fully assembled radio is also thoroughly tested before being sent out to the customer. Though the actual tests are long and detailed, a listing of the tests performed before any SG-2000 is shipped to a customer will indicate our commitment to providing the best radio possible.

23.5.1 Pre Rack #1 Tests

The following are the tests performed on each SG-2000 before going on Rack #1 for 12 hours of continuous 100 W CW transmitting on 1.9 MHz into our light bulb antenna load:

Serial number assignment

Bench inspection (visual, ohms, volts, etc.)

PLLs voltage check and adjustment

Receive SSB sensitivity check

Receive AM sensitivity check

AGC check

ALC 150/50 W transmit adjustment

Carrier insertion check and adjustment

150/50 W power check for for 1.6 to 30 MHz

Head functions check

Communication with SGC Base Station

Antenna mismatch protection in transmit

Recovery at power supply failure

135 W RF Out spectrum quality adjustment

RS-232 port check

11.94 oscillator check

Installation on Rack #1 for 12 hour transmit test and Test Log entry



23.5.2 Pre Rack #2 Tests

The following tests are done to the SG-2000 after 12 hours on Rack #1 and before 12 hours continuous cycling 150 W CW transmitting on 4.5 MHz into the light bulb antenna load on Rack #2:

Inspection before removal from Rack #1

Bench inspection (visual, ohms, serial, etc.)

PLLs voltages check and adjustment

Receive SSB sensitivity check

Receive AM sensitivity check

ALC 150/50 W transmit adjustment

Carrier insertion check and adjustment

150/50 W transmit adjustment

Head functions check

Communication with SGC Base Station

11.94 oscillator check and adjustment

Installation on Rack #2 and Test Log entry

23.5.3 Pre Exit Tests

After 24 hours on the testing racks and before any unit goes out the door, it receives these final inspections:

Inspection before removal from Rack #2

Bench inspection (visual, ohms, serial, etc.)

Receive SSB sensitivity check

Carrier insertion check and adjustment

150/50 W power check for 1.6-30 MHz

SGC Smartuner™ check

Head functions check

Communication with SGC Base Station

11.94 oscillator check and adjustment

24.0 Schematic Reference Section

INCLUDING PART LOCATION DIAGRAMS

Page 181	Exciter Schematic	J30100920 sh 1 of 6
Page 182	Exciter Schematic	J30100920 sh 2 of 6
Page 183	Exciter Schematic	J30100920 sh 3 of 6
Page 184	Exciter Schematic	J30100920 sh 4 of 6
Page 185	Exciter Schematic	J30100920 sh 5 of 6
Page 186	Exciter Schematic	J30100920 sh 6 of 6
Page 187	LPA Schematic	J30100500 sh 1 of 2
Page 188	LPA Schematic	J30100500 sh 2 of 2
Page 189	Display Schematic	J30100910 sh 1 of 2
Page 190	Display Schematic	J30100910 sh 2 of 2
Page 191	Microprocessor Schematic	J30100930 sh 1 of 2
Page 192	Microprocessor Schematic	J30100930 sh 2 of 2
Page 193	Microprocessor Head Schematic	J30100935 sh 1 of 1
Page 194	Mic In Schematic	J30100913 sh 1 of 1
Page 195	AM Rejection Filter Schematic	J30100921 sh 1 of 1
Page 196	Exciter PCB Layout , MicroProcessor/Exciter Interface Section	J40100920-1
Page 197	Exciter PCB Layout, VCO and Time Base Section	J40100920-2
Page 198	Exciter PCB Layout, Attn/RF Amp/Power Supply Section	J40100920-3
Page 199	Exciter PCB Layout, SSB Filter/IF Amp/AM Det Section	J40100920-4
Page 200	LPA, PCB Layout	J40100500
Page 201	Display Head, PCB Layout	J40100910
Page 202	MicroProcessor/Head, PCB Layout	J40100935
Page 203	MicroProcessor/Exciter, PCB Layout	J40100930
Page 204	Key Pad Matrix	J20100200
Page 205	Rear Panel Parts Layout and Interconnections	J40100300
Page 206	Block Diagram, Head	J40100550
Page 207	Block Diagram, Exciter	J40100920
Page 208	Block Diagram, LPA	J40100500
Page 209	Block Diagram, MicroProcessor	J40100930,35



J30100920 sh 1 of 6



J30100920 sh 2 of 6



J30100920 sh 3 of 6



J30100920 sh 4 of 6



J30100920 sh 5 of 6



J30100920 sh 6 of 6



J30100500 sh 1 of 2



J30100500 sh 2 of 2



J30100910 sh 1 of 2



J30100910 sh 2 of 2



J30100930 sh 1 of 2



J30100930 sh 2 of 2



J30100935 sh 1 of 1



J30100913 sh 1 of 1



J30100921 sh 1 of 1



J40100920-1



J40100920-2



J40100920-3



J40100920-4



J40100500



J40100910



J40100935



J40100930



J20100200



J40100300



J40100550



J40100920



J40100500 Block Diagram



J40100930, 935



Index

11.94 MHz Reference Oscillator Test	132	Begin Scanning	66
20 dB Attenuator Check	138	Broadcast Band Filter	108
20 dB Attn	54	Button Functions	170
30 MHz Low-Pass Filter Adjustment	142	Cabling	30
600 ? Port/ Audio Out Check	139	Carbon Microphone Level Check	170
600? Port Check	141	Carrier Insertion Adjustment	142
About the SG-2000	10	CHAN	49, 52
AC Power Supplies	31	Change Channel - Telex Mode	61
Additional Control Heads	28	Change Channel - Voice Mode	60
AGC Adjustment	138	Change Channel Scan Rate	
Alarm Generator	116	(In Channel Scan Mode)	69
Alarm Generator Check	143	Change Frequency Scan Rate	
Alarm Start	111	(In Frequency Scan Mode)	68
ALC Check	142, 161	Change Frequency Scan Step	69
ALE and Adaptive Controllers	100	Changing Frequency or Channel	
ALE Controller - Command Examples	103	Scan Rates	68
AM Filter Bypass	113	Channel	42, 59, 60
AM Mode Alignment	137	CHANNEL FUNCTIONS	45
Antenna Couplers	37	Channel Scan	42, 47
Antenna Feed Lines	37	Clarifier Use	62
Antenna Systems	34	Clock / Date	55, 59, 70
Antenna Wire Size	35	Clock Test	173
Attenuator	71	Computer Control of SG-2000	3
Auto-Answer Devices	87	Computer Networks - Serial Control	87
Automatic Level Control	118	Continuous Duty Ratings	23
AUTOMATIC LINK ESTABLISHMENT -		Control Circuits	12
ALE	100	Control Head Installations	27
Back Light	57, 72	Control Head Number Display	72
Band Scan	42	Control Head Placement	16
Bar Graph	51	Control Head Wiring	17
Base Station and Fixed Antennas	36	Control Heads	13
BASIC FUNCTIONS	44	Coupler Port Check	143
Basic Tune-up Procedure (Alignment)	112	Crystal Oven	117
Battery Installation (Main CPU only)	173	CW key	108
Beep	58, 72	CW Level Adjustment	140
		Data Communications	3
		Data In/Out Check	173
		DEFINE MEMORY	47
		Delete	58, 72
		Delete a Channel from Memory	64



Deleting Errors in Entry	64	Head Port Audio Out	139
Dimensions and Weight	4	HI LO	51
Display	58	High Seas Direct™ Connections	82
Display (Date / Time)	72	History of the SG-2000	8
Display Alarm Time OFF	70	Installation	21
Display Alarm Time ON and Frequency	69	Intcm	51
DISPLAY TESTING PROCEDURES	163	Intcm / Xcv	55
Dynamic Microphone Level Check	170	Intercom	71
Emergency Calling	111	Internal Accessories	5
Enter a Duplex Channel into Memory	64	Key Functions	44
Enter a Simplex Channel into Memory	63	LCD Display Test	165
Exciter Testing Procedures	129	LCD Installation	164
Exsel-100 Selective Calling System	106	LCD Numerals	50
Extension of Control Head Wiring	85	Line of Demarcation	86
External Accessories	5, 18	Load Frequency Limits	66
External Coupler Installation	22	Location of Power Supplies	16
External Modem, Weatherfax and High Seas Direct™	23	Lock Feature	59
External Software	88	Lock for Channelized Operation Only	73
External Speakers	17	Lockout	58, 73
Filter Bands Sweep	159	LPA	127
Fine Tuning - CW Operation	63	LPA Testing Procedures	156
FREQ	49, 56	LSB - USB	53
Frequency	59, 61	Marine Radio Mounting	80
FREQUENCY FUNCTIONS	44	Marine Antennas	82
Frequency Change - Direct Entry	61	Marine Ground Systems	80
Frequency Change - General	61	Marine Installation	80
Frequency Change - Incremental	62	Marine Use	48
Frequency Scan	42	Master oscillator with Oven	114, 117
Front Panel	43	Memory	42
Front Panel Controls	52	Microphone Enabling Test	169
Front Panel Display	49	Microphone Level Adjustment	140
FWD	50	Microphone Voice Check	170
FWD - SWR	58, 73	Microprocessor Assembly	114
General Description of SG-2000	1	MicroProcessor Assembly	115
GPS Software	15	MicroProcessor Ports Test	172
Ham Radio Use	48	Mobile Antennas	38
Hard Disk Installation	90	Mobile Grounds	76
HEAD CPU and MAIN CPU TESTING PROCEDURES	171	Mobile Installation	75
		Mobile Power Supplies	32
		Mode	53



MODE FUNCTIONS	45	Radio Licenses	19
Modulation Characteristics, Audio		Rate	58
Frequency Response	118	RCV	49
Modulation Characteristics, Peak		Recall a Selected SG-2000 Memory into	
Envelope Power Limiting	119	Active Use	103
Multiple Control Head Specifications	4	Receive Audio Test	165
Near Vertical Incidence Skywave	36	Receive Sensitivity Check	134
Noise Blanker	58, 72	Receive Troubleshooting	143
Oil Platform Software	15	Receiver Signal Path	10
Operating Session	59	RECEIVER SPECIFICATIONS	2
Operating the SG-2000	41	Red LEDs	51
Operational Test	174	Remote Control	85
Operator Licenses	20	Remote Head Cable Extension	29
Oscillator and Filter Operation	113	Remote Head Kit Installation	27
Output Low Pass Filters	118	Remote Mobile Heads	14
oven Switch	116	RS-232 Serial Control Software	88
PC Cable Assembly	98	RS-232 Software Installation	89
Phone Level Check	167	RS-232 Software Main Menu Display	92
PLLs	114, 115, 129	RS-232 Software Main Menu	
Power	59	Operations	93
Power Failure Recovery Check	143	RS-232 Software Menu 2 Operations	95
Power HI-LO	71	RS-232 Software Programming	
Power Requirements	2	Functions	96
Power Supplies	30	RS-232 Software Technical Support	91
PowerTalk™	9, 14	RS-232 Software Troubleshooting	91
PowerTalk™ SA	14	Running Software from Floppy Drives	90
Precautions	6	S Meter Test	166
Prgm	49, 52	S or SWR	50
Primary Keyboard Functions	52	Sample Entries	48
Program a Channel Bank	65	Scan	49, 56, 59
Program Functions	59	Scan Bank	42
Program Time ON Frequency	70	Scan by Channel Banks	68
Program Time ON-OFF	70	Scan by Channels	67
Program Timer on Channel	70	Scan by Frequency - General	65
Program User Channel into Memory	63	Scan by Frequency - Specific Range	66
Programmed Scan	42	SCAN FUNCTIONS	46
Programming	63	Scanning Functions	64
PWR Hi / Lo	55	Scanning in One Direction Only	128
QMS Recommended for Mobile Use	39	SCHEMATIC REFERENCE	
Rack Mount Kit Installation	24	SECTION	180



Serial Communication Protocol	102	TELEREX™	18
Serial Logic Switches	114	TELEREX™ ARQ/FEC/SELFEC	
Serial Logic Switches	116	System	107
Set Clock	71	Temp	51, 127
Set Date	71	Temperature Sensor Check	162
SG-2000 Connections to		Temporary Settings	74
ALE Controller	104	TEST EQUIPMENT SET-UP	
SG-2000 Front Panel	13	FOR SG-2000	122
SG-2000 MicroProcessor Reset		Timer	50, 56, 59, 69
Procedure	110	TIMER FUNCTIONS	47
SG-2000 Performance		Tone Generator	114
Measurements	121	Tone Generator	116
SG-2000 Performance Specifications	2	Transformer-Rectifier Supplies	31
SG-2000 Rear Panel	13	Transmit Alignment	160
SG-2000 Rear Panel Connections	21	Transmit Calibration	140
SG-2000 Serial Port Operation	101	Transmit Channel Locking	73
SG-2000 Software and Accessories	15	Transmit Frequency Monitor	74
SG-2000 Test Procedures	129	Transmitter Signal Path	11
SHIFT FUNCTIONS	46	TRANSMITTER SPECIFICATIONS	3
Shift Functions	57	Trouble Shooting	127
Shift/ Func	52	Unconventional Mobile Antennas	40
Shock and Vibration Mounting	75	Unload Frequency Limits	67
Short Haul Modems/ Auto-Answer		Unlock Channelized Only Operation	73
Devices	86	Unpacking	7
SITOR	13, 15, 18, 53, 54, 57, 61, 67	User Memory	42
SlimPak	9	VCO	114, 115, 129
Small Numerals	50	VCO Check	132, 133
Solar Powered Chargers	33	VCO Troubleshooting	144
Speaker Clipping Level Check	169	Vehicular Noise Sources	78
Speaker Level Check	167	View Timer	57
Spk	54, 127	Voc - Tlx	54
SQL	54, 127	Voice/Telex Filters Check	139
SQL Level	57	Voltage Values for the Exciter PCB	145
Squelch Scale Recalibration	110	Volume	71
Squelch Test	168	XMT	49
SSB Alignment	136		
SSB Transmit Alignment	141		
Standard Features	4		
Station Licenses	19		
Step	58		

